

The how-to magazine of electronics...

ELECTRONICTM

Servicing & Technology

NOVEMBER 1986/\$2.25

Dealing with power line problems • Scoping TV power supply

Component pitfalls • ABCs of voltage regulator ICs

Micromounting microchips with a laser pen

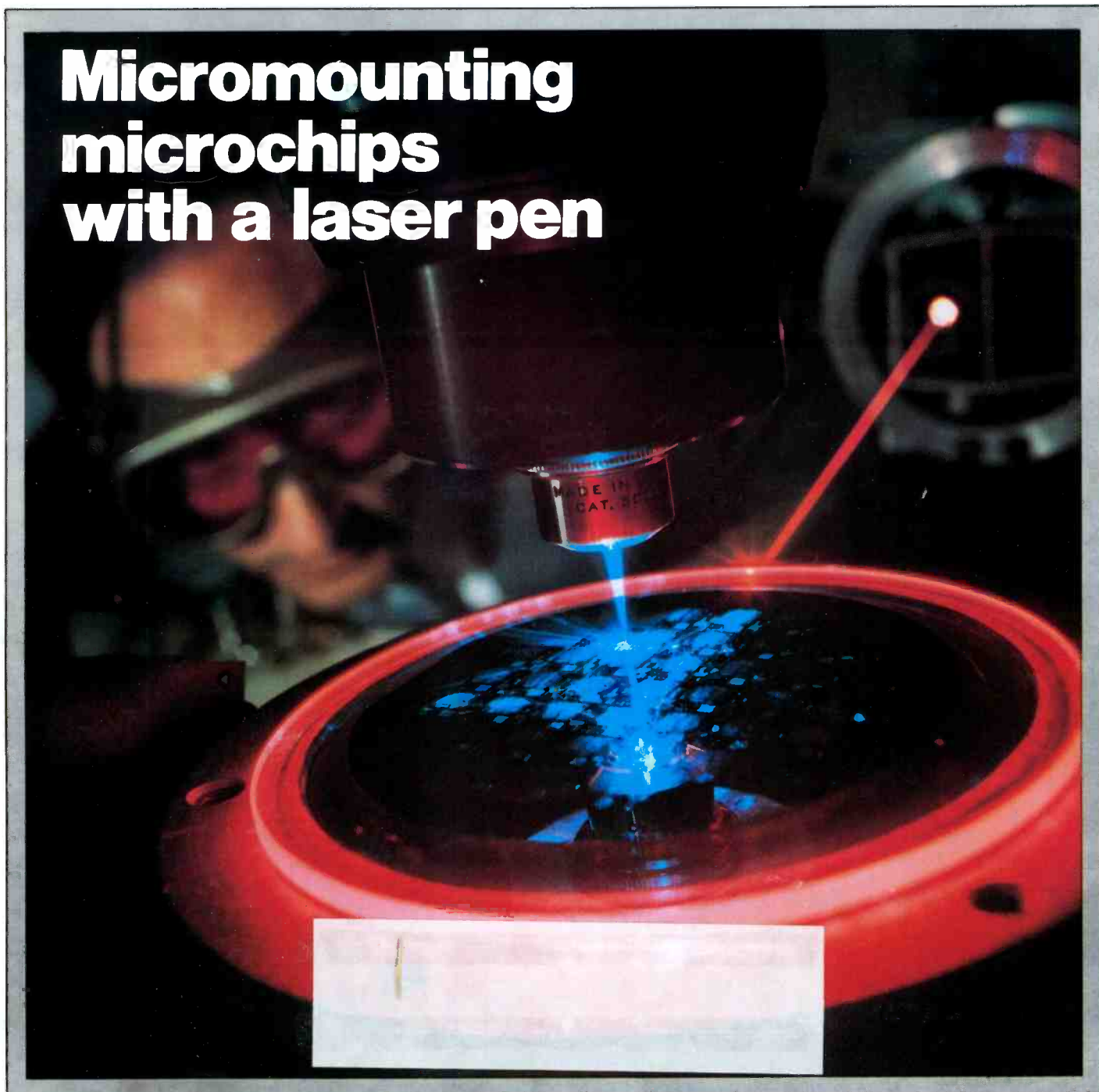

New GPS Series: Tek sets the pace with SmartCursors™ and push-button ease.

Work faster, smarter, with two new general purpose scopes from Tektronix. The four-channel, 100 MHz 2246 and 2245 set the new, fast pace for measurements at the bench or in the field. They're easy to use and afford, by design.

On top: the 2246 with exclusive integrated push-button measurements. Measurements are accessed through easy, pop-up menus and implemented at the touch of a button. Measure peak volts, peak-to-peak, \pm peak, dc volts and gated volts with new hands-off convenience and on-screen readout of values.

SmartCursors™ track voltmeter measurements in the 2246 and visually indicate where ground and trigger levels are located. Or use cursors in the manual mode for immediate, effortless measurement of waveform parameters.

Both scopes build on performance you haven't seen at the bandwidth or prices. Lab grade features include sweep speeds to 2 ns/div. Vertical sensitivity of 2 mV/div at full bandwidth for low-level signal capture. Plus trigger

Features	2246	2245
Bandwidth	100 MHz	100 MHz
No. of Channels	4	4
Scale Factor Readout	Yes	Yes
SmartCursors™	Yes	No
Volts Cursors	Yes	No
Time Cursors	Yes	No
Voltmeter	Yes	No
Vertical Sensitivity	2 mV/div	2 mV/div
Max. Sweep Speed	2 ns/div	2 ns/div
Vert/Hor Accuracy	2%	2%
Trigger Modes	Auto Level, Auto, Norm, TV Field, TV Line, Single Sweep	
Trigger Level Readout	Yes	No
Weight	6.1 kg	6.1 kg
Warranty	3-year on parts and labor including CRT	
Price	\$2400	\$1875

sensitivity to 0.25 div at 50 MHz, to 0.5 div at 150 MHz.

Accuracy is excellent: 2% at vertical, 2% at horizontal. And four-channel capability includes two channels optimized for logic signals.

Best of all, high performance comes with unmatched convenience. You can see it and feel it — in the

responsive controls and simple front-panel design, in extensive on-screen scale factor readouts, and in simplified trigger operation that includes Tek's Auto Level mode for automatic triggering on any signal. Start to finish, the GPS Series saves steps and simplifies tasks.

Get out in front! Call toll-free today to order, to get more details or a videotape demonstration.

1-800-433-2323

In Oregon, call collect 1-627-9000

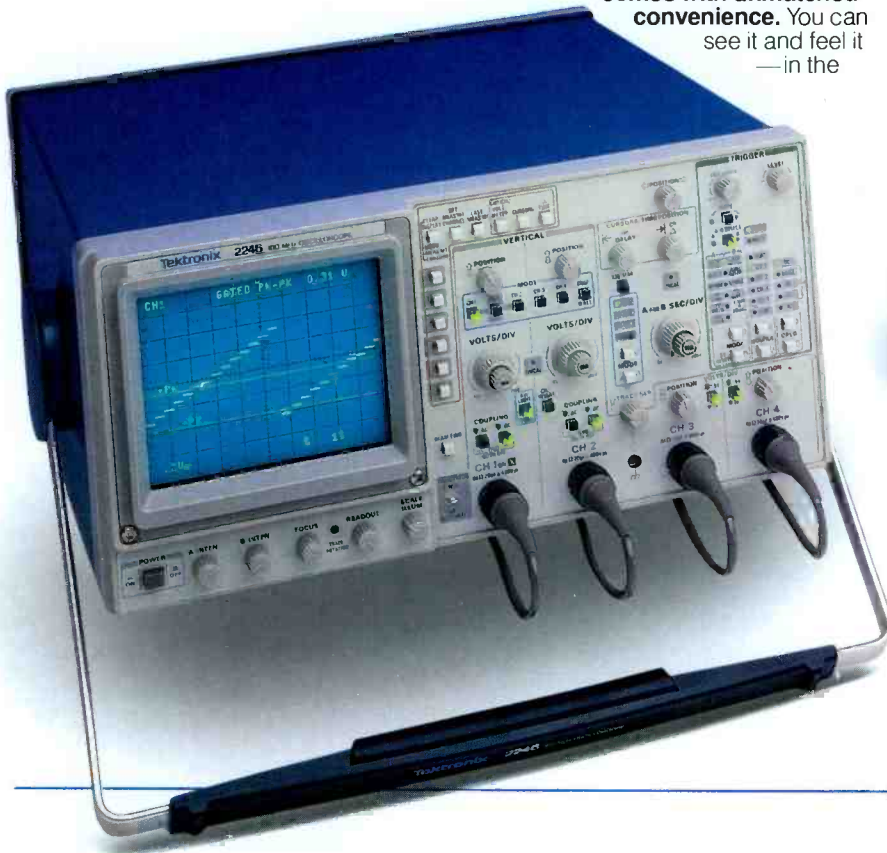

Featuring four channels, flexible triggering, extensive CRT readouts and push-button ease of use, the new Tek 2246 (left) and 2245 (above) bring high-quality, low-cost analysis to diverse applications in digital design, field service and manufacturing.

Tektronix
COMMITTED TO EXCELLENCE

Circle (1) on Reply Card

PROFIT FROM THE MILLION-DOLLAR VCR SERVICE & REPAIR INDUSTRY

VCRfacts™

TECHNICAL SERVICE DOCUMENTATION



VCR Coverage Includes

FISHER		PV1310	VCR75	V-T193	VCR67
FVH-530		PV1370	VCR70	V-T250	VCR70
(SN 10,001)		PV1470	VCR68	V-T450	VCR68
THRU 70,000)	VCR-77 **	PV1500	VCR19	V-T456	VCR68
FVH-520	VCR-78 **	PV1600	VCR36	V-T650	VCR72
FVH-615	VCR-79 **	PV1650	VCR53	V-T654	VCR72
FVH-730	VCR-80 **	PV1750	VCR60	VGT200	VCR74
FVH-530		PV1770	VCR72	VGT203	VCR74
(SN 70,001		PV1780	PF 2340*	VGT205	VCR76
& LATER)	VCR-81 **	PHILCO		VGT207	VCR76
FVH-510	VCR-82 **	V1011	VCR67	VGT225	VCR75
FVH-515	VCR-83 **	V1012	VCR74	VGT650	PF 2375*
FVH-525	VCR-84 **	V1300	VCR39		
FVH-715	VCR-85 **	V1001QBK01	VCR76	SANYO	
FVH-720	VCR-86 **	V1333QBK01	VCR75	VR3900	PF 2396 (1)*
FVH-720R	VCR-87 **	V1441	VCR70	VCR3900-11	PF 2396 (1)*
FVH-721	VCR-88 **	V1500	VCR45	VCR4000	PF 2396 (1)*
FVH-722	VCR-89 **	V1550	PF 2312*	VCR4000-2	PF 2396 (1)*
FVH-725	VCR-90 **	V1551	VCR68	VCR4300	PF 2284
		QUASAR		VCR5000	VCR40
GE		VH5000	VCR8	VTC9100A	VCR50
1VCR1010W	VCR62	VH5010	VCR20		
HITACHI		VH5011TW	VCR67	564 53030700	VCR13
VT-5000 A	VCR17	VH5021	VCR74	564 53040700	VCR13
JC PENNEY		VH5022UW	VCR76	564 53050800	VCR15
685-5006-00	VCR41	VH5030SW	VCR65	564 53060900	VCR37
685-5007-00	VCR44	VH5040SW		564 53180150/151	PF 2284*
685-5018-00	PF 2375*	(Early Production)	VCR61*	564 53110250	PF 2396 (1)*
686-5010-00	PF 2312*	VH5040SW	VCR56*		
686-5012-00	VCR67	VH5100QW	VCR22	SHARP	
686-5013-00	VCR68	VH5125UW	VCR75	VC8000	VCR52
686-5020-00	VCR75	VH5155RW	VCR46	SL2500	VCR73
686-5021-00	VCR76	VH5210TW	VCR70	SL5000	VCR69
		VH5310TW	VCR68	SL5400	VCR27
JVC		VH5310TW	VCR72	SL5400	VCR33
HR3300U	VCR5	VH5610TW	VCR72	SL5800	VCR64
HR3600AU	VCR21	VH5623UW	PF 2340*	SL7200A	VCR1
HR6700U	VCR49			SL8200	VCR7
		RCA		SL8600	VCR10
MAGNAVOX		PPP600	VCR71	SYLVANIA	
VH8000	VDP1	SPT100W	VDP2	YC2210	VCR67
VH8200BRO1	VCR4	TFP1500	VCR71	YC2212	VCR74
VJ8220BRO1	VCR18	TFP1504	VCR71	YC2700	VCR30
VJ8225BRO1	VCR24	VBT200		YC2910	VCR70
VK8222BRO1	VCR35	(Early Production)	VCR2	YC2215BK01	VCR76
VK8227BRO1	VCR47	VBT200 (From Serial		YC2950BK01	VCR75
VK8229BRO1	VCR51	8033FM001)	VCR9	YC3000	VCR38
VR8306BK01	VCR76	VCT200	VCR9	YC3100	PF 2312*
VR8315BK01	VCR67	VCT201	VCR16	YC3110	VCR68
VR8316BK01	VCR74	VCT300	VCR16	YC3610	VCR72
VR8318BK01	VCR75	VCT400	VCR11	YC3620BK01	PF 2354*
VR8325BK01	VCR70	VDT201	VCR25	TOSHIBA	
VR8330BK01	VCR63	VDT350	VCR23	VS310C	VCR32
VR8330BK02	VCR58	VDT501	VCR28	VS310T	VCR32
VR8335BK01	VCR68	VDT555	VCR31	VS420C.T.U	VCR59
VR8345BK01	VCR72	VD7600	VCR34		
VR8346BK01	PF 2354*	VD7625	VCR43	ZENITH	
PANASONIC		VET180	VCR55	JR9000P.W	VCR3
PV1000	VCR6	VET250	VCR57	KR9000W	VCR12
PV1100	VCR14	VET253	VCR57	YR8900W	VCR69
PV1200	VCR26	VET450	VCR48	YR9000W	VCR29
PV1265	VCR76	VET650	VCR54	YR9700J	VCR42
PV1270	VCR67	VFP170	VCR71	YR9750J	VCR66
PV1275	VCR74	VFP174	VCR71	YR9775PT	VCR73
		VFT190	VCR67		

*PHOTOFACT® Format

**VCRfact Format
Manual Format-Specialized Series Manuals

VCR-76 last VCR "Manual" published -
VCR's now covered in PHOTOFACT.

*VCR-61 has 2 system control boards

*VCR-56 has 1 system control board.
(1) March Release.

Make Money--Save Time-- Make Repairs Easier

Increase productivity. Accelerate turnaround. Profit with quality, dependable, service documentation from the people who have provided repair data to technicians for over 40 years... Sams.

At \$21.95 each, VCRfacts will more than pay for themselves with a single repair. Less time spent on repairs will increase turnaround time that creates customer loyalty, repeat business, and referrals. VCRfacts can be even more affordable through Sams "Bonus-Buy Plan" for volume discounts.

VCRfacts technical service documentation is available from local electronics distributors, or from Sams. For information about where you can get VCRfacts, call toll-free **800-428-SAMS**.

HOWARD W. SAMS & COMPANY

4300 West 62nd Street
Indianapolis, Indiana 46268 USA

12

Dealing with power line problems

By Conrad Persson

Here's how to safeguard delicate electronics equipment from damaging power fluctuations: those sags, surges and other transients that cannot be anticipated.

24

Why do components fail?

By Victor Meeldijk

These case histories of failed components confirm that self-destruction unintentionally has been designed into some components; improper handling and contaminants cause others to fail.

30

Test your electronic knowledge

By Sam Wilson

Quiz questions are based on technologies described in the July and August issues. Have you been reading attentively or just hitting the high spots? A subscriber writes that *his* company has a monthly testing session as soon as **ES&T** is received!

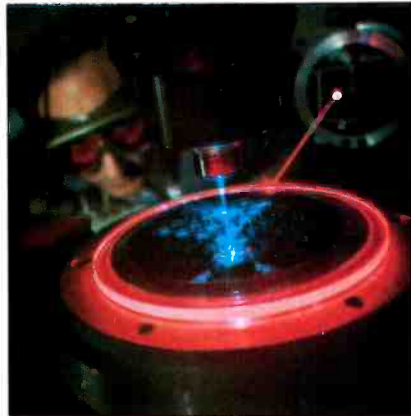

Page 11

Laser pens interconnect microchips.

(Photo courtesy General Electric Research and Development Center.)



Page 24

Optoisolator with incandescent bulb.

39

ABCs of voltage regulator ICs

By Joseph J. Carr, CET

What is it that people have forgotten that causes so many negative voltage regulators to be trashed? And why are substitutes readily available for the 3-terminal version?

46

Scoping TV power supply sources

By Bud Izen, CET/CSM

Tough dogs roll over for technicians who know, and review, fundamentals, remembering that the power supply is the most frequent source of failure.

52

What do you know about electronics? –

Microprocessor tuning

By Sam Wilson

Exemplifying one of the reasons why the microprocessor was developed – to simplify and perfect an electronic function using a minimum of associated circuitry – the microprocessor tuner eliminates mistuning and consequent, distorted sound.

Departments:

- 6 Editorial
- 8 News
- 9 Literature
- 10 Feedback
- 11 Technology
- 51 Books
- 51 Photofact
- 57 Troubleshooting Tips
- 58 Audio Corner
- 60 Products
- 61 Reader's Exchange
- 62 Computer Corner
- 64 Symcure

Final hazard waste rules affect many small businesses; EPA HANDBOOK CAN HELP

Many businesses that generate small quantities of hazardous waste, such as cleaning fluids for electronics, have come under regulations similar to those that currently apply to large generators. Final regulations for small quantity generators were issued by the Environmental Protection Agency on March 24, under the 1984 amendments to the Resource Conservation and Recovery Act (RCRA). These rules took effect on Sept. 22, 1986.

To assist small businesses in complying, EPA has prepared "Understanding the Small Quantity Generator Hazardous Waste Rules: A Handbook for Small Business," which was published this fall and already distributed by many trade and professional associations. To obtain a free copy, call EPA's RCRA/Superfund Hotline (1-800-424-9346, except in the District of Columbia, where the number is 382-3000), the EPA Small Business Hotline (1-800-368-5888), an EPA regional office or a participating state hazardous waste management agency.

Businesses that generate small quantities of hazardous waste are divided into two categories. *Conditionally exempt* generators are those that produce no more than 100kg of hazardous waste in a calendar month. (One hundred kilograms fill about one-half of a 55-gallon drum and weigh about 220 pounds.) These generators are required to

- identify all hazardous waste produced;
- send waste to a hazardous waste facility or a landfill approved by the state for industrial or municipal wastes, and
- accumulate no more than 1,000kg of hazardous waste on-site.

Different rules apply to businesses that generate more than 100kg but less than 1,000kg of hazardous waste in a calendar month (that is, between one-half and five 55-gallon drums, or between 220 and 2,200 pounds). When the new rules took effect on Sept. 22, these 100kg to 1,000kg/mo generators are now regulated in much the same way as businesses generating larger amounts of hazardous waste have been regulated for some time. They are now required to take four specific actions:

1.) *Obtain a U.S. EPA Identification Number*—This can be done by completing a "Notification of Hazardous Waste Activity" form (EPA Form 8700-12), which can be ob-

tained from state hazardous waste management agencies or EPA regional offices. Generators are required to use the form to report all types of hazardous waste produced, identified by EPA hazardous waste number. (An instructional booklet containing EPA hazardous waste numbers will be provided with the form.) They will be asked to send the form to the appropriate contact for their state, also listed in the instructional booklet. Each generator then will be assigned a 12-character U.S. EPA Identification Number, which must appear on all shipping papers (that is, manifests) that accompany waste off-site for treatment, storage, or disposal.

2.) *Learn and follow EPA's rules for storing or managing hazardous waste on-site*—To enable businesses to accumulate enough waste to make shipment economical, EPA's rules allow 100kg to 1,000kg/mo generators to store waste on the premises for 180 days or, if the waste is to be shipped more than 200 miles away, for 270 days, as long as no more than 6,000kg are accumulated. Operations that exceed these time or quantity limits will be considered hazardous waste storage facilities, and they will be required to obtain storage permits and meet all RCRA storage requirements—a costly and time-

consuming undertaking. (The effective date for rules covering storage for more than 180 days has been extended to March 24, 1987, as has the effective date for rules affecting certain kinds of on-site treatment and disposal.)

While waste is accumulating, generators are required to follow certain waste management procedures designed to reduce risks to health and the environment:

- Adhere to storage standards that can reduce risks of leaks and spills. These standards include labeling containers "Hazardous Waste" and writing the collection date on the label; checking containers and tanks periodically for leaks, corrosion, or other damage; making sure that wastes that could react together to cause fire, leaks, or other releases are not stored together; and keeping containers and tanks covered (or providing at least two feet of space at the top of uncovered tanks). More details are found in the handbook.
- Develop a plan to deal with emergencies. Such a plan should outline possible accident or emergency scenarios and lay out steps that should be taken in each case. For example: Who should be contacted if a container leaks, and what steps should be taken to clean it up? What should be done in the event of a fire or spill of hazardous waste? What emergency equipment should be used? Who will be responsible? Planning for emergencies involves training employees to handle hazardous waste and deal with accidents. One employee must be designated "Emergency Coordinator" and be available 24 hours a day.
- Find out what emergency equipment is needed, based on the operations and type of waste handled, and make any necessary arrangements with local fire and police departments and hospitals.

3.) *Select a hazardous waste hauler and treatment, storage, or disposal facility with a U.S. EPA Identification Number*—State hazardous waste management agencies can determine if a hauler has an EPA Identification Number.

Businesses are potentially liable for mismanagement of wastes even after the shipment leaves their premises. Therefore, haulers and designated facilities should be chosen carefully. Business associates, trade associations, and local Better Business Bureaus and Chambers of Commerce may have information on reliable haulers and facilities. Generators should

Continued on page 7

Getting along with power problems

Not much before 100 years ago, electricity was little more than a curiosity. It was a mysterious phenomenon that had found limited success in operating streetcar motors and as a source of electric light. Its practicality to transmit power over long distances was yet to be demonstrated. Homes were still lighted for the most part by oil or gas. There were no electrical appliances. There were no electric power lines to homes.

The introduction of Edison's practical electric lamp in 1879, rapidly followed by success in building practical electrical distribution systems, started the developed nations down the road to universal, or almost universal, availability of electrical power.

In the early years, there were immensely important decisions to be made and technical obstacles to overcome. Should transmission be by ac or dc? At what voltage? Once the relative advantages of ac were clearly understood, a frequency standard had to be agreed on.

And once the decisions were made and the kinks worked out, the world where electricity was available was transformed! Night was turned into day. Homes could be illuminated with the flick of a switch. Gradually, electrical appliances were introduced: The electric washer replaced the scrubboard, the electric fan provided a cool breeze at any time. The electric stove, toaster, vacuum cleaner and much more followed.

For years, for the most part, the production, transmission and consumption of electricity went smoothly. The power companies, whether owned by investors or communities or the federal government, provided reliable power of the specified voltage and frequency so that lamps glowed, fans hummed, electric clocks kept good time and refrigerators kept food fresh and cold.

The success of the electrical utilities in providing power is attested to by

our attitude toward it. When we go out on, say, a cold winter's day, we do so without a thought that the power might fail. We are confident that in our absence the power will be there to generate the heat, or operate the heating controls to keep our homes warm. There's not a second thought as to whether the refrigerator will be fed a constant supply of power to keep our food from spoiling. We expect that when we get home the clocks still will say the correct time.

But recently something's changed—dramatically. The same power that has been perfectly acceptable for nearly a hundred years is in many cases not acceptable for today's generation of consumer electronic products. Subtle (and sometimes not-so-subtle) problems, from memory lapse in a computer or spontaneous resetting of a clock, to near-total destruction of a product, has led investigators to determine that many of these problems are caused by irregularities in the line power delivered by the utilities.

Some people are of the opinion that the power companies have been doing them a disservice by delivering power that's not *clean*. Part of the problem, though, is simply that today's delicate electronics products are sharing power lines with heavy electrical equipment whose starting and stopping causes sags or surges or imposes large spikes on the line. In fact it has been shown that in many cases much of the *dirt* that shows up at the power outlet is generated within the same building.

For the near term at least, the only answer to the problem seems to be that owners of modern electronics equipment that's sensitive to power line disturbances must assume that there are in fact disturbances on the power line and take appropriate precautions.

Nils Conrad Persson

Statement of Ownership, Management and Circulation
(Act of August 12, 1970; Section 3685, Title 39, United States Code).

1. Title of publication: Electronic Servicing & Technology
- 1A. 462-050
2. Date of filing: Sept. 20, 1986
3. Frequency of issue: Monthly
- 3A. Number of issues published annually: 12
- 3B. Annual subscription price: \$18.00 U.S.
4. Location of known office of publication (Street, city, county, state, zip code): 9221 Quivira Rd., Overland Park, Johnson County, Kansas 66215.
5. Location of the headquarters or general business offices of the publishers (not printers): 9221 Quivira Rd., Overland Park, Johnson County, Kansas 66215.
6. Names and complete addresses of publisher, editor, and managing editor. Publisher (Name and Complete Mailing Address): Eric Jacobson, 9221 Quivira Rd., Overland Park, Kansas 66215. Editor (Name and Complete Mailing Address): Nils Conrad Persson, 9221 Quivira Rd., Overland Park, Kansas 66215. Managing Editor (Name and Complete Mailing Address): Dan Torchia, 9221 Quivira Road, Overland Park, KS 66215.
7. Owner (If owned by a corporation, its name and address must be stated and also immediately thereunder the names and addresses of stockholders owning or holding 1 percent or more of total amount of stock. If not owned by a corporation, the names and addresses of the individual owners must be given. If owned by a partnership or other unincorporated firm, its name and address, as well as that of each individual must be given. If the publication is published by a nonprofit organization, its name and address must be stated.) Intertec Publishing Corp., a Macmillan Inc. company, 9221 Quivira Rd., Overland Park, KS 66215.
8. Known bondholders, mortgagees, and other security holders owning or holding 1 percent or more of total amount of bonds, mortgages or other securities (If there are none, so state): None.
9. Paragraphs 7 and 8 include, in cases where the stockholder or security holder appears upon the books of the company as trustee or in any other fiduciary relation, the name of the person or corporation for whom such trustee is acting, also the statements in the two paragraphs show the affiant's full knowledge and belief as to the circumstances and conditions under which stockholders and security holders who do not appear upon the books of the company as trustees, hold stock and securities in a capacity other than that of a bona fide owner. Names and addresses of individuals who are stockholders of a corporation which itself is a stockholder or holder of bonds, mortgages or other securities of paragraphs 7 and 8 when the interests of such individuals are equivalent to 1 percent or more of the total amount of the stock or securities of the publishing corporation.
10. This item must be completed for all publications except those that do not carry advertising other than the publisher's own and are named in sections 132,231, 132,232 and 132,233, postal manual (Sections 4355a, 4354b, and 4356 of Title 39, United States Code).

	Average No. Copies Each Issue During Preceding 12 Months	Single Issue Nearest To Filing Date
--	--	-------------------------------------

A. Total No. Copies Printed (Net Press Run)	56,326	52,300
B. Paid and/or Requested Circulation		
1. Sales through dealers and carriers, street vendors and counter sales	109	110
2. Mail subscriptions	51,918	50,462
C. Total Paid Circulation	52,027	50,572
D. Free Distribution (including samples) by mail, carrier delivery or other means	2,779	854
E. Total Distribution (Sum of C and D)	54,806	51,426
F. Office use, left-over, unaccounted spoiled after printing	1,502	874
G. Total (Sum of E and F should equal net press run shown in A)	56,326	52,300

I certify that the statements made by me above are correct. (Signature of editor, publisher, business manager, or owner.)

ERIC JACOBSON
Publisher

Continued from page 5

also know and comply with the Department of Transportation (DOT) regulations that apply to labeling and packaging of wastes.

4.) *Prepare a manifest, including DOT shipping description for hazardous wastes*—When shipping wastes off-site to a treatment, storage, or disposal facility, a business is required to complete a multi-copy hazardous waste manifest, which is designed to accompany the waste from point of generation to final destination. Depending upon the requirements of the

states involved, generators should obtain the appropriate manifest form from one of three sources: 1. the state to which the waste is being shipped; 2. the state in which the waste was generated; or 3. EPA, in that order. Many hazardous waste haulers and facilities customarily provide appropriate manifests to their customers. For three years after shipment, businesses are required to keep on file a copy of each completed manifest, signed by the hauler and the designated facility.

ES&T

CALL TOLL FREE
Include work address and phone number for Free Catalog.

800-824-2873

SCOPES

IWATSU



- All 14 models in stock
- 2-3 year warranties
- 20-250 MHz

MODEL	PRICE
5702	\$ 535
5705	\$ 899
5710	\$1245
5711	\$1695
5706	\$ 749

HITACHI V-222

Portable Dual Trace Scope

SALE \$535

LIST \$715⁰⁰

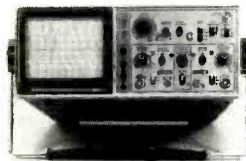

- DC-20 MHz
- 3-Way Power Supply
- Lightweight
- High Sensitivity and Fast Sweep Timer

HITACHI Hitachi
Denshi America, Ltd.

- All 20 models in stock
- 2-3 year warranties
- 20-100 MHz

MODEL	PRICE
1050	\$1299
509	\$1199
VC 6041	\$4400
422	\$ 690
1100	\$1900
650	\$ 930
V209	\$ 725
1070	\$1595
1100A	\$2490
V222	\$ 550

DIGITAL MULTIMETERS

BECKMAN
Beckman Industrial

- All 300, HD, and Circuitmate series
- All accessories in stock

MODEL	PRICE
HD100	\$169
HD110	\$189
HD130	\$239
HD140	\$259
300	\$120
310	\$145
320	\$179
330	\$219
350	\$229
360	\$289
4410	\$239

FLUKE FLUKE

- Autorange
- Touchhold function
- 0.3% accuracy
- Heavy duty Analog display

MODEL	PRICE	MODEL	PRICE
73	\$ 79	75	\$ 99
21	\$ 99	23	\$145
25	\$229	27	\$259
8010A	\$279	8012A	\$359
8020B	\$199	8022B	\$154
8024B	\$249	8050A	\$389

FLUKE 77

SALE

\$114

LIST \$139⁰⁰



Analog/Digital Multimeter

POWER SOURCES

POWER DESIGNS

- Low and high voltage power sources
- 1-5 year warranties

MODEL	PRICE
2020B	\$750
2K20	\$695
4050	\$660
6150	\$725
TW5005W	\$595
TW6050A	\$880
TW347	\$695
TP340	\$750
TP343A	\$795

USED TEST EQUIPMENT, TOO!—OVER 3,000 MODELS AVAILABLE AT HUGE DISCOUNTS WITH WARRANTIES!

■ Quantity Discounts Available ■ Dealers Welcome ■ Freight and Tax Extra ■ Immediate Availability of Equipment

US United States Instrument Rentals, Inc.

A U.S. Leasing Company
2988 Campus Drive
San Mateo, CA 94403

Circle (4) on Reply Card

Homenet proposed as standard: other proposals invited

Judson Hofman (Matsushita Technology Center), chairman of the EIA Consumer Electronics Bus (CEBus) Committee, has announced that the General Electric Company proposed its Homenet protocol to the committee for use as a power line control system.

Hofmann, whose committee also invited the submission of other proposals, explained that Homenet provides standardized communication for the exchange of control information among devices and services such as lights, appliances, security and heating and cooling. The power line is important because it represents a convenient communications channel. No decision had been announced by press time.

This committee, which is sponsored and staffed by EIA's Consumer Electronics Group, is a broadly based panel representing manufacturers, users and other organizations with a business interest in home control systems. It is currently in the process of devel-

oping standards for systems that use the power line, infrared, dedicated wiring (including coaxial cable and/or fiber optics), and radio.

New measurement standard for tape recorders

The Electronic Industries Association has announced the availability of EIA-518, "Tape Recorder Measurement Standard." This new recommended standard is a revision and update of interim standard No. 12, published in 1984.

EIA-518 is the result of an industrywide effort to promote standardization in the measurement of consumer high-fidelity analog tape recording and reproducing equipment. Particularly noteworthy is the establishment of reference levels to which various specifications such as signal-to-noise ratio, maximum recorded level, and meter calibration are referred. Ambiguities arising from variations in the choice of reference input and output levels also have been addressed in this new standard so that products may be meaningfully compared by consumers attempting to choose suitable products for use in a high-fidelity system.

This document was developed by the EIA R-3 committee on audio systems, under the chairmanship of Bert Locanthi of Pioneer North America.

Copies of EIA-518 may be obtained from the Electronic Industries Association, Standards Sales Office, 2001 Eye Street N.W., Washington, DC 20006 at the price of \$18 per copy.

EIA predicts home video sales to exceed 31 million in '86

The Consumer Electronics Group of the Electronic Industries Association (EIA) recently predicted that 17.3 million color televisions, 13.2 million VCRs and 1 million camcorders will be sold to dealers during calendar 1986. Sales by midyear appeared to confirm this prediction.

At the time of EIA's semi-annual report, every home video category was running well ahead of last year's pace, including color television (up 7%), B&W (up 5%), projection (up 22%), VCR (up 15%) and camcorders (up 363%).

In July alone, more than 1.2 million color TV sets were sold to dealers, up 7% as compared with July 1985. Black and white television continued to show renewed strength, expanding nearly 16% last month relative to the same month a year ago. Projection TV sales were up nearly 32% in July, and camcorders (VCR/camera combinations) jumped more than 300% above their July 1985 levels.

ELECTRONIC

Servicing & Technology

Editorial, advertising and circulation correspondence should be addressed to: P.O. Box 12901, Overland Park, KS 66212-9981 (a suburb of Kansas City, MO); (913) 888-4664.

EDITORIAL

Nils Conrad Persson, *Editor*
 Carl Babcoke, *Consumer Servicing Consultant*
 Dan Torchia, *Group Managing Editor*
 Marjorie Riggin, *Associate Editor*
 Joy Culver, *Editorial Assistant*
 Darryll Fortune, *Editorial Assistant*
 Alisa Carter, *Editorial Assistant*

CONSULTING EDITORS

Homer L. Davidson, *TV Servicing Consultant*
 Christopher H. Fenton, *Circuit Design Consultant*
 Bud Izen, *Computer Servicing Consultant*
 Victor Meeldijk, *Components Consultant*
 Kirk G. Vistain, *Audio Consultant*
 Sam Wilson, *Electronics Theory Consultant*

ART

Kevin Callahan, *Art Director*
 Tim Lynch, *Graphic Designer*

BUSINESS

Cameron Bishop, *Group Vice President*
 Eric Jacobson, *Publisher*
 Greg Garrison, *Sales Manager*
 Stephanie Fagan, *Promotions Manager*
 Kelly Hawthorne, *Marketing Assistant*
 Dee Unger, *Advertising Supervisor*
 Julie Chilson, *Advertising Coordinator*

Regional advertising sales offices are listed in classified pages.

ADMINISTRATION

R. J. Hancock, *President*
 John C. Arnst, *Circulation Director*
 Jo Ann DeSmet, *Circulation Manager*
 Dee Manies, *Reader Correspondent*



Member, Audit Bureau of Circulation



Member, American Business Press



Member, Electronic Servicing Dealers Association

ELECTRONIC SERVICING & TECHNOLOGY (USPS 462-050) (with which is combined Electronic Technician/Dealer) is published monthly by Intertec Publishing Corp., 9221 Quivira Road, P.O. Box 12901, Overland Park, KS 66212-9981. Second Class Postage paid at Shawnee Mission, KS 66201. **Send Form 3579 to P.O. Box 12952, Overland Park, KS 66212-9981.**

ELECTRONIC SERVICING & TECHNOLOGY is the "how-to" magazine for technicians who service consumer electronics equipment. This includes service technicians, field service personnel and avid servicing enthusiasts, who repair and maintain audio, video, computer and other consumer electronics equipment.

SUBSCRIPTION PRICES: one year \$18, two years \$30, three years \$38 in the USA and its possessions. Foreign countries: one year \$22, two years \$34, three years \$44. Single copy price \$2.25; back copies \$3.00. Adjustment necessitated by subscription termination to single copy rate. Allow 6 to 8 weeks delivery for change of address. Allow 6 to 8 weeks for new subscriptions.

PHOTOCOPY RIGHTS: Permission to photocopy for internal or personal use is granted by Intertec Publishing Corp. for libraries and others registered with Copyright Clearance Center (CCC), provided the base fee of \$2 per copy of article is paid directly to CCC, 21 Congress St., Salem, MA 01970. Special requests should be addressed to Eric Jacobson, publisher.

ISSN 0278-9922 \$2.00 + 0.00



©1986 All rights reserved.

Literature

CPS Electronics makes available a 4-color illustrated brochure describing its consumer-grade product line of Electra Guard surge suppressors that respond within 3ns and prevent power surges from damaging microprocessor-based equipment. The product line includes 1- to 8-outlet units with special features such as indicator lights, push-button circuit breakers, lighted *on/off* switches and EMI/RFI protection. Telephone and data line surge suppressors, back-up power systems and power control centers are also described.

Circle (125) on Reply Card

A 40-page color catalog by **ESP Electronic Specialists** describes products for hi-tech equipment and microcomputer protection. Uninterruptible power supplies, line conditioners, modem protectors, equipment isolators, spike suppressor/filter combination and ac power interrupters are listed in the complete application specifications.

Included are tutorial sections describing various problem situations and corrective action to be taken. The catalog describes standard, off-the-shelf products, custom designs and Hot Line problem solving.

Circle (126) on Reply Card

A videotape program available from the **3M Static Control Systems Division** discusses ways to minimize ESD damage to sensitive electronic components during field service operations. Titled "How to Avoid Static from All Sides," the 20-minute videotape is designed to increase static awareness among management and field personnel specifically in the electronic field service industry.

Circle (127) on Reply Card

"Metric Mart" is a bimonthly sales brochure published by **Metric Resources** that describes sale items, "best buys" and closeouts from this company's \$100 million

inventory of used electronic, industrial and telecommunications test equipment, desktop computers/controllers and microprocessor development systems. Prior to delivery, all equipment is tested, calibrated and inspected according to manufacturers' original performance specifications. Ninety-day warranties are included.

Circle (128) on Reply Card

Anyone contemplating a technical career might wish to check the **National Association of**

Trade and Technical Schools (NATTS) "Trade and Technical Careers and Training" handbook. Accredited private schools throughout the country that offer skill training are listed, both alphabetically by type of career and by state.

Circle (129) on Reply Card

Carter-Craft's Accessories Catalog V-86 may be used as a handy reference guide as well as a source for video, VCR and cable-TV equipment.

Circle (130) on Reply Card **ES&T**

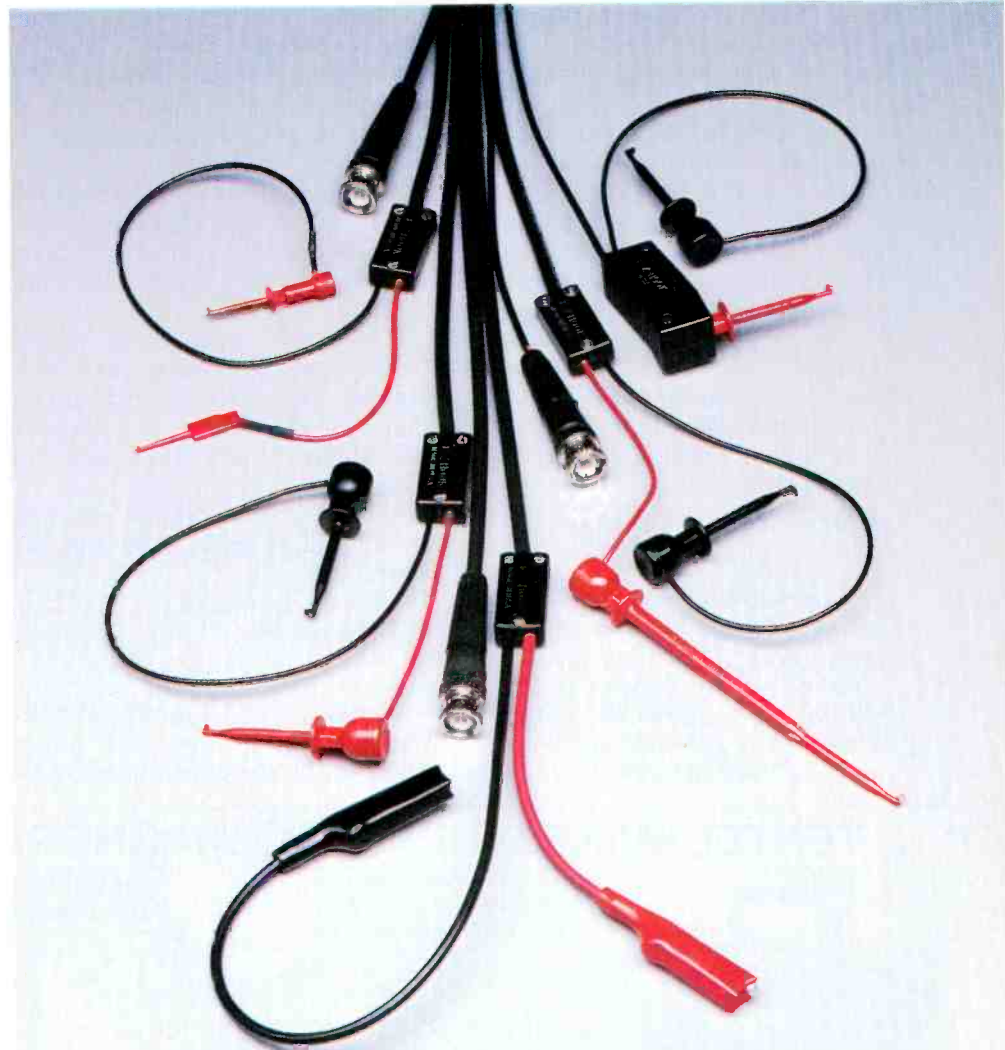

PROBES AND LEADS ANYWAY YOU WANT THEM. STANDARD.

From our 112-page Catalog, or to suit your special needs. Unequaled reliability, immediate shipment, service and selection.

E-Z-HOOK®

E-Z HOOK, A Division of Tektest, Inc., 225 North Second Ave., Arcadia, CA 91006
P.O. Box 450, (818) 446-6175. TWX 910-582-1614.
Circle (6) on Reply Card

Feedback

A 10-year index?

I've been a subscriber for about 10 years. We have gotten a lot of good info from your magazine.

Frequently, we will remember reading an article or Syncure or tough dog sometime or other, but can't remember the month.

We then are hunting through a hundred or more back issues looking for what we may or may not have seen.

You used to print that in your December or January issue, but no more. We miss that feature.

Would it be possible to get an index of articles, Syncures, tough dogs for the past 10 years updated semiannually?

I would be willing to pay for such an index, but I don't know whether enough technicians would be interested to make it worthwhile for you to do it...just a thought.

Jim Watkins
Dayton, OH

As a matter of fact, Mr. Watkins, we have been publishing an annual index of articles each year, that lists all of the articles published during the previous year. In December of 1985, we published the index of 1985 articles. In January

of 1985, we published the index of 1984 articles. In February of 1984, we published the index of 1983 articles. In December of 1982, we published the index of 1982 articles.

Indexing articles, or for that matter any extensive collection, for 10 years as you suggest, becomes a prohibitive job. Until now we have simply not had the resources to assign to it. It sounds as though it would be a helpful adjunct to the magazine. We can't make any promises, but we'll at least look into the magnitude of the task and see if there's anything we can do. Ed.

Our readers are tops

I would appreciate very much if you would put a short note of thanks in your Feedback department.

Several months ago, I asked for information (in Reader's Exchange) regarding information on model KCT1950 color television; the front marking was KTV.

I received a total of 11 replies from many locations; one from Hawaii. The address for the information that I needed is KTV Inc., 341 Michele Place, Carlstadt, NJ 07072.

My thanks to everyone who was so helpful. I now have the set operating.

W. Wilson Loveless
Tallahassee, FL

Thank you, Mr. Loveless, for taking the time to write and let us know about the amazing response

you received from other ES&T readers to your Readers' Exchange item, and for sharing the information you received with other readers. And a thank you from the staff of ES&T to all of you readers who took the time to provide information to Mr. Loveless to help him get this TV set working again, and to all of you readers who have ever taken a moment to respond to a request that has been published in Readers' Exchange. Ed.

Letter to Kirk Vistain

I really enjoy your Audio Corner article in *EST*. I am a student of electronics and very interested in the servicing and repair of musical instrument amplifiers and related equipment.

I have a specific question for you. What do you recommend using as a dummy load for a 50W or 100W musical instrument speaker when performing a circuit test that involves injecting a signal and observing waveforms throughout the circuits?

Steven M. Hartnett
St. Ann, MO 63074

You need a non-inductive resistor of 4Ω or 8Ω. I'd recommend a Dale RH250 which is rated 8Ω @ 250W. If you need 4Ω, you can buy two and parallel them. Using such a high power resistor for a 50WA or 100WA ensures that it (the resistor) will not overheat and be damaged.

Kirk Vistain

TENTEL MAKES IT EASY TO DIAGNOSE VCR MECHANICS



Award winning Tentelometer tape tension gauge for proper interchange and tape handling. One gauge for Beta, VHS and U-Matic.

T2-H7-UM \$295



Torque gauge NEW from Tentel to save you money— Universal and accurate for Beta and VHS— 0 to 600 gm cm. Take-up, FF and Rew torques.

TQ600 \$129

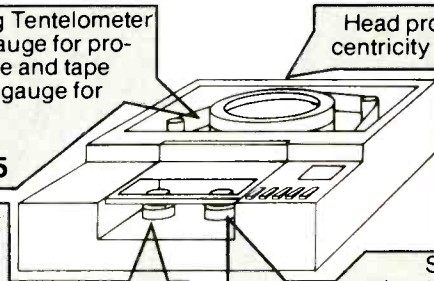

Head protrusion and eccentricity gauge to determine the amount of wear remaining on the VCR heads; safe, easy, measures in microns.

HPG-1 \$479

Spindle height and elevator latch and alignment gauge to diagnose cassette binding and edge damage problems. Finds problems not detected by any other method.

TSH-V4 \$395



Tentel manufactures a complete line of gauges for U-matic, 1" Type "C", Betacam and other recorders, too. If you've suffered the frustration of having a master tape ruined, or if you are responsible for maintaining and repairing VCRs— There's no faster, easier method to test the various mechanics that make VCRs work properly. Call our technical engineering dept. for details—ask about the combo discount for all 4 gauges. We've been helping customers for years and want to help you too—your satisfaction is guaranteed.

TENTEL CORP. 1506 Dell Ave.
Campbell, CA 95008

(408) 379-1881
800 538-6894 (Not in CA)

Circle (7) on Reply Card

Micromounting microchips with a laser pen

A microchip can contain tens or hundreds of thousands of transistors in an area the size of a baby's fingernail. Technicians know this. They also know that present-day interconnections, relatively speaking, are bulky: Microchips can be mounted no closer than approximately 1/4-inch.

At General Electric Research and Development Center, scientists are resorting to a laser *pen* in developing new ways to package more compactly the components of high-speed computers. Using lasers, these researchers *draw* extremely short, thin metallic interconnections among microchips mounted on a circuit board.

"In the tiny world of microelectronics, that (1/4-inch) is a vast distance," says Dr. Lionel M. Levinson, the R&D Center program manager who heads the laser study. "One result is that signals can spend more time traveling from one chip to another than they do being processed."

The goal is to find ways to shrink drastically the distance that an electrical signal has to travel among a computer's various memory, logic and other microchips, thereby increasing the speed at which the machine can process data.

The electrons that comprise a signal hurtle through a computer's circuits at close to the speed of light: 186,000 miles per second. Because nothing can travel faster than the speed of light, an obvious way to increase a computer's speed is to move its microchips closer together.

Presently, a microchip is mounted in a bulky ceramic package that then is plugged into a printer circuit board. The individual packages are linked together by relatively thick and long electrical conductors printed on the board.

Key to the new approach is the



An intense beam of light from a laser scribes microscopic lines that connect integrated circuits on the surface of a material.

laser beam's intense heat and light, which can trigger chemical reactions in different materials. The beam can bring about pyrolysis (heat-induced chemical change) or photolysis (light-induced chemical change). In both cases, the intense laser beam serves as a catalyst. A network of ultrafine circuit lines is created by means of laser-triggered deposition of metal.

The feasibility of this technique, called direct deposition, was demonstrated by R&D center scientists before a U.S. Office of Naval Research contract was awarded. In initial experiments, they succeeded in laying down tungsten lines measuring just one micron across. (One micron is a millionth of a meter, or 1/50 the diameter of a human hair.)

An argon laser was employed to draw these fine lines on the surface of a material placed in a sealed chemical vapor deposition cell. After the air was pumped out of the cell, tungsten-hexafluoride gas was fed into it. Then, the laser was switched *on* and its beam focused through a window in the cell onto the surface.

As the scientists slowly moved the laser beam, its energy caused the tungsten to be stripped from

the gas and deposited as a thin metallic line on the surface of the sample. The scientists were able to draw the lines at a speed of several centimeters per second.

In other preliminary experiments, the GE researchers demonstrated that laser deposition also worked with such conductors as zinc, aluminum, molybdenum, platinum, copper and gold.

This technique offers a number of potential advantages over alternative deposition methods. Unlike conventional approaches, it is a low-temperature procedure carried out at atmospheric pressure and doesn't require a furnace. Nor does it need the *masks* by which circuit patterns are conventionally printed on a substrate. Because only the laser beam touches the surface of the circuit board, the new technique offers the prospect for a quick turnaround time and an ability to draw lines on surfaces not perfectly flat.

Finally, the laser technique also offers the potential of excellent *step coverage*, eliminating any breaks or thinning of the circuit lines that can occur when connections are made around corners or from one level to another across the surface of a microchip or circuit board.

The General Electric R&D Center, Schenectady, NY, has been awarded a 2-year, \$790,000 contract by the U.S. Office of Naval Research for this study's further development.

Dealing with power line problems

Presented here is a sampling of the power protection devices currently available, taken from new product information provided by the manufacturers. The protection mentioned is that claimed by the manufacturer and has not been confirmed by this magazine.

By Conrad Persson

Most people don't think about power very much. We take for granted that electrical power that's adequate for whatever electrical appliances we choose to use in the house will be delivered by the power company. In most cases, that assumption is correct. For electric lights, motors and similar equipment, the power delivered by the utility is perfectly adequate. Even in the case of electronic products, the power is almost always adequate.

But just because the power is *adequate*, that doesn't mean that it doesn't cause problems with some of the more sophisticated electronic products we use.

Most of the food we eat gives us the nutrients we need to operate our bodies, but if the food contains contaminants or inimical bacteria, we may get sick. If you give your car a steady diet of clean gasoline, it will perform as expected. Given a tankful of gas that contains dirt, moisture or other contaminants, it

might run rough, refuse to start or even worse, be damaged enough to need repair.

You can't see the contaminants in your food that might make you sick, but by selecting your food carefully and cooking it properly, you can avoid most problems. By being careful where you buy your gas and changing your gas-line filter occasionally, you may be able to avoid most causes of damage to your car's engine.

Unfortunately, you can't shop

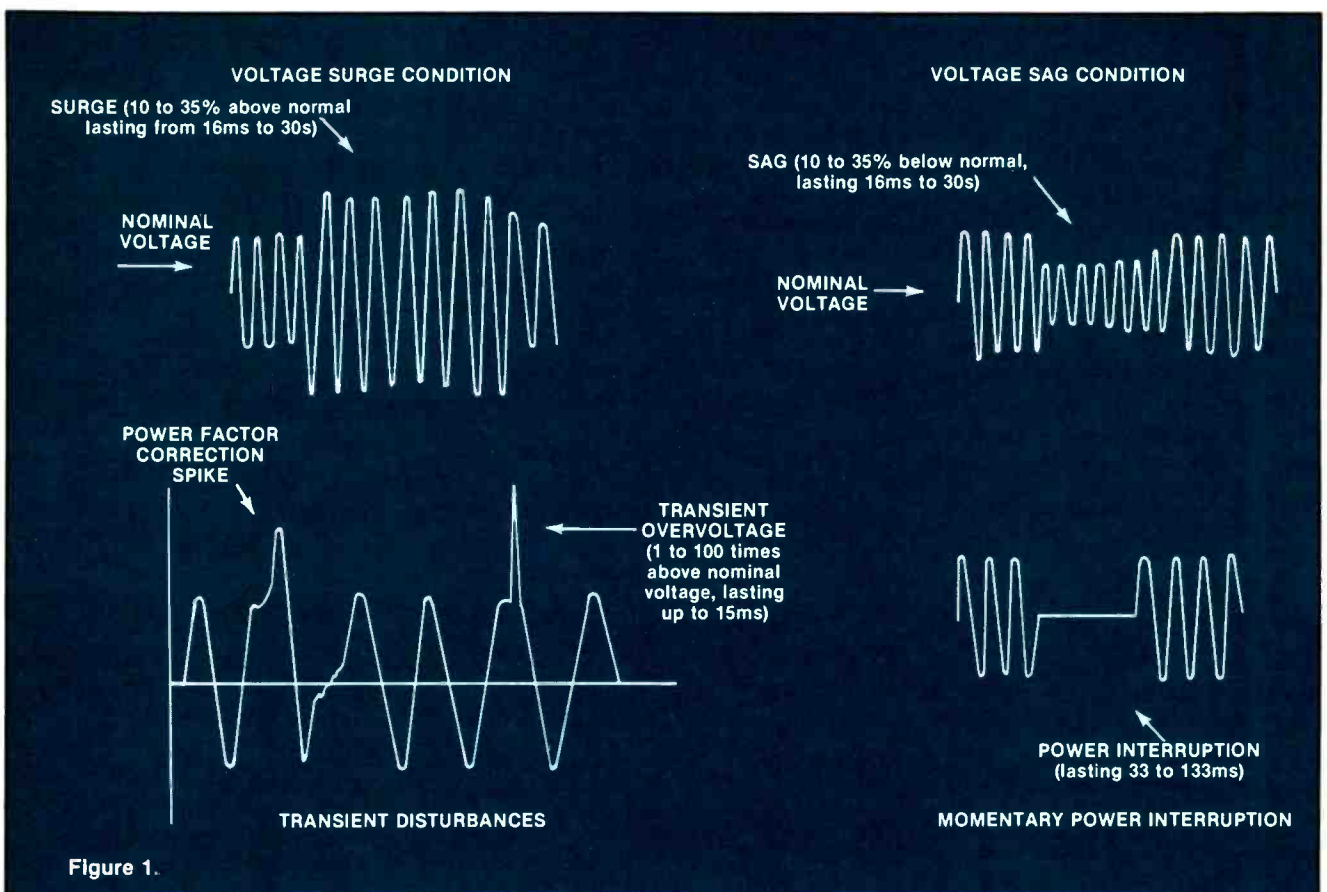

Figure 1.

for your electrical power, so if your local utility is giving you dirty power, you're stuck with it. But if that is the case, just as contaminated food will make you sick and contaminated gasoline can damage your engine, contaminated power may damage some consumer electronic products.

Causes of power problems

Utilities don't willfully transmit contaminated power. Ordinarily they take great pains to make sure that the voltage and frequency are within specifications. Actually, when you think about the fact that we expect to have adequate power available to our homes 24 hours a day, every day of the year, year in and year out without even the occasional Sunday off, the utilities do a remarkable job.

In spite of power companies' best efforts, though, the nice smooth 60Hz sine wave coming down the wire is subjected to many kinds of aberrations that may cause it to deviate from its nominal conditions, or that may superimpose spurious electrical signals on the 60Hz signal. Here are some of the problems, their causes and their possible effects on consumer electronic devices.

Undervoltage—Undervoltage is the term for the existence of a lower-than-normal voltage on the ac line over an extended period of time. Another term for this phenomenon is brownout. In some cases, this condition is imposed intentionally by the utility company during periods of heavy usage in order to spread less-than-adequate power production capacity over *all* their customers, rather than cut off *some* of their customers.

In other cases, a brownout may be unintentional, occurring simply as a result of excessive power consumption causing excessive voltage drop on certain lines, resulting in decreased voltage at the outlets of customers.

Undervoltage is frequently damaging to such things as electric motors, which may run less effi-

ciently, overheat and become damaged. Most electronic products are relatively unaffected by moderate levels of undervoltage because of built-in tolerances and regulation. Significant undervoltages may drop below the threshold voltage value needed by an elec-

tronic product and cause it to cease operation entirely.

Overvoltage—Overvoltage is the term for the existence of a higher-than-normal voltage on the power line for an extended period of time. Whether or not an overvoltage

<p>Desoldering Tool SALE \$15⁹⁵ EA.</p> <p>20 - 240 Volt. 150/60Hz. 25 - 30 Watt. Can be used for both soldering and desoldering. BM-483</p> 	<p>Video Head VEH 0070 SALE \$37⁹⁵ EA.</p> <p>Panasonic type head used in 2-4 hour recorder system. T-682</p> 	<p>Audiophile Headphone with Volume Control and Walkman Style Adapter SALE \$24⁹⁵ EA.</p> <p>BM-398</p> 
<p>CRT Brightner with Isolation Transformer T-681 SALE \$8²⁵ EA.</p> 	<p>GE Voltage Suppressor GESP-753 UL Listed T-700 SALE \$15⁹⁵ EA.</p> 	
<p>Telephone Amplifier SALE \$10⁹⁵ EA.</p> <p>BM-406 Easy Installation</p> 	<p>4 Amp Power Supply SALE \$18⁷⁵ EA.</p> <p>DM-231</p> 	
<p>BM-306</p> <p>46 Channel Block Converter with Fine Tune Control SALE \$19⁹⁵ EA.</p> 	<p>DM-474</p> <p>10" Replacement Woofer 8 ohm 35/70 Watt SALE \$29⁹⁵ EA.</p> 	<p>DM-317</p> <p>SALE \$39⁰⁰ EA.</p> <p>200 Meg/Ohm Digital Multitester AC or DC, w/battery. Display boxed.</p> 
<p>ESI ORDER BY PHONE 800-645-4720 IN NYS CALL: (718) 436-9700</p> <p>Electronic Parts & Accessories a unit of ALPHA-KENCO INC. 3820 14th Avenue, Brooklyn, NY 11218</p> <p>call for our free CATALOG</p> <p>Master Card VISA</p>		

Circle (5) on Reply Card

These two 6-outlet surge suppressors available from RCA are the Power Safe, which protects equipment powered by this device from transient voltages, and the Power Safe Plus, which protects against transients and also filters out noise with a high frequency bidirectional filter.

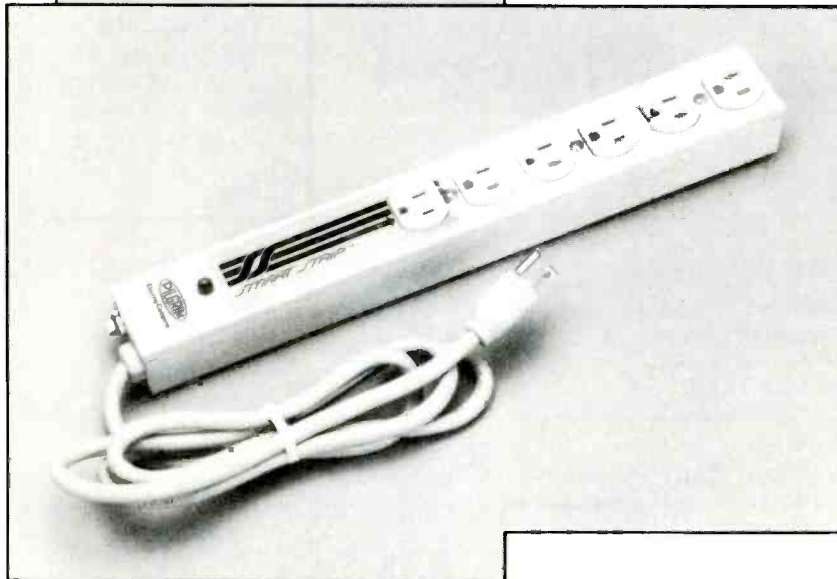
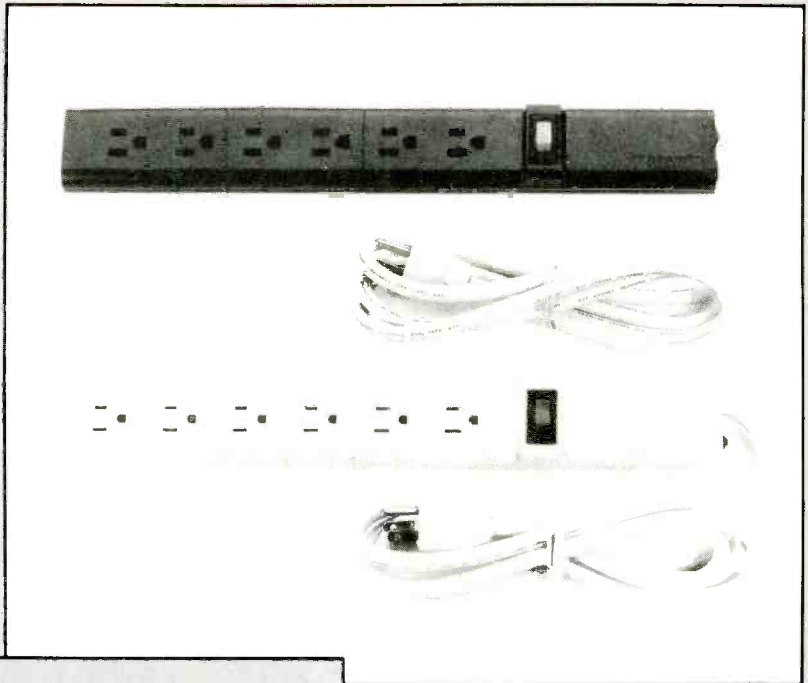

The Smart Strip II from Pilgrim Electric Company protects equipment from transient overvoltages and line noise. One of the outlets is a Smart Socket, into which you plug whichever piece of equipment that you wish to have come on first. When the device plugged into the Smart Socket is switched on and begins drawing current, the rest of the outlets are automatically turned on.

An on-line, sine wave uninterruptible power supply, from Electronic Specialists Inc., supplies up to 20 minutes of power during extended power outages. Wideband EMI/RFI filtering and high-speed, high-current suppression are incorporated. Included is integral overload/short circuit protection.



Looking At The Future

- - - From The Past

Copyrighted DIEHL 1986 Amarillo, Texas

The closed loop circuits in late model TV sets are becoming more and more difficult to service. Just when you feel you have a handle on the parts that repeatedly fail in any given chassis, and think to yourself that you have solved your start up and shut down problems for awhile, a totally different string of parts begin to show up in that same chassis that cause the same identical symptom. In spite of the fact that the same symptom is on the screen (usually nothing more than a very quiet, blank screen), the new wave of parts failures turn out to be in an entirely different portion of the horiz, hi-voltage, LV, LV regulator circuit, or in some scan derived B+ source that no one would ever suspect, much less consider.

Before they can even begin to function, many (or most) late model TV sets first require a "start up" B+ pulse for the horiz oscillator, and another such "short term" supply of initial B+ voltage for the horiz driver stage. Both of these "initial" start up pulses must be supplied by the primary low voltage power supply. Specifically, they must originate from some point in the LV supply that is located between the LV rectifiers and the B+ side of the primary winding of the horiz sweep transformer.

Once the horiz osc/driver stages begin to cycle, the secondary side of the flyback must begin to provide its own B+ voltage, which will then be used to **keep** the horiz osc/driver stages running once the initial start up B+ source has been depleted. Thus, as a technician, when it comes to troubleshooting the horiz oscillator or driver stages, you are now dealing with four totally

independent circuits (the start up circuit, scan B+ "run" circuit, the oscillator, and the driver circuit), and not just the horiz oscillator and driver circuit.

But, it doesn't end there!

The low voltage regulator circuit in most late model TV sets will employ any number of shut down sensors. If for example, the video output stage is shorted, the start up circuit will still start the oscillator/driver stages, the horiz output stage will still "cycle" the primary of the flyback, the flyback will still begin producing scan derived voltage, but the secondary winding of the flyback that supplies B+ voltage for the video output stage will be "loaded down" by the shorted video output transistor. That secondary winding will run into magnetic saturation, the entire iron core of the flyback will "saturate", the output level of the flyback will be low, the insufficient output of the flyback will "trigger" any one of four or five LV regulator shut down circuits, the LV regulator will promptly shut down, and, - - - the technician who is witnessing this sequence of events will have no possible way of knowing whether the oscillator failed, the driver failed, the start up circuit failed, the LV regulator, primary B+ or the flyback itself has failed!

It still doesn't end there!

Many late model sets now employ a "sustaining pulse" circuit that takes a 60 hz pulse from the **vertical** output circuit, and applies this same 60 hz pulse to the LV regulator drive circuit.

At first glance, it almost appears that the design engineers are creating these "special effect" circuits just to make service more difficult for field technicians.

- - - NOT TRUE!

In fact, such circuits are nothing less than a stroke of genius once you analyze their purpose and function.

Based on the law of physics, anything that either loads, or unloads one secondary winding of a transformer, will effectively produce the same results at all other secondary windings with regards to voltage output. That is, if you "short out" one winding, you will drastically reduce the voltage output of all other windings. If you "open" a given winding, you will drastically increase the voltage output of all other windings. Its all a matter of volts/amps, which is the primary design criteria of **all** transformers.

This in itself tells you that "opening" or "shorting" a secondary winding that for example feeds the vertical output stage, will have a much greater effect on all other secondary windings, than doing likewise to a secondary winding that supplies nothing more than an agc pulse. **WHY!** Because the vertical output stage requires far more amperage to drive it than does the agc circuit.

Why were sets designed this way?

Imagine a TV set in which all of the circuits, except for the horiz output stage, operate off of a wide assortment of scan derived B+ sources. This same TV set is running along just fine, when suddenly, the vertical output or the R-B-G video output stage becomes open due to an open resistor or transistor.

Continued on page 17

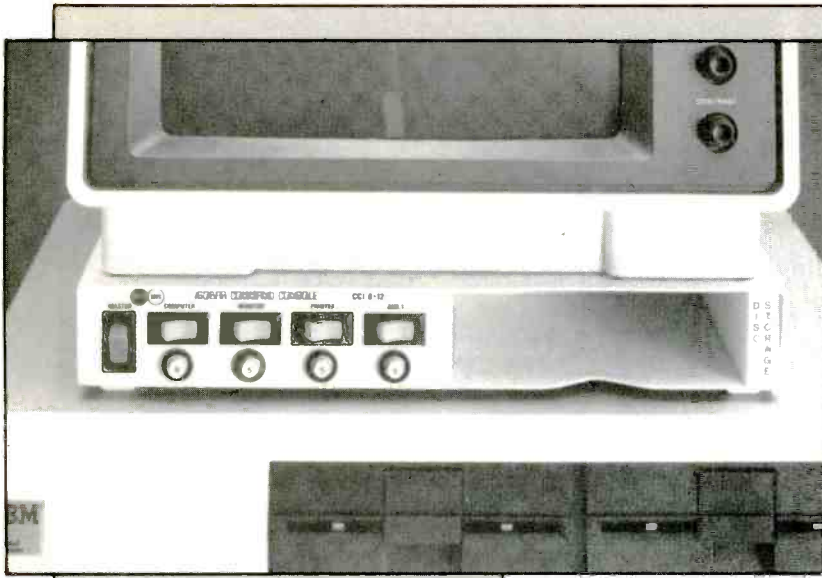

The IsoBar Command Console, available from Tripp Lite, provides a centralized power control console complete with full spike/surge and RFI/noise protection for computers and peripherals. The unit, which incorporates an individual circuit breaker for each duplex receptacle, is designed to be located between a personal computer and the monitor, and offers a diskette storage compartment.

This combination ac line filter and transient surge suppressor, the model 023 from PMC Industries, features three separate filter banks and surge suppressor circuits, each individually switch/lighted. This construction allows protection not only from the incoming line, but from other instruments plugged into other filter banks.

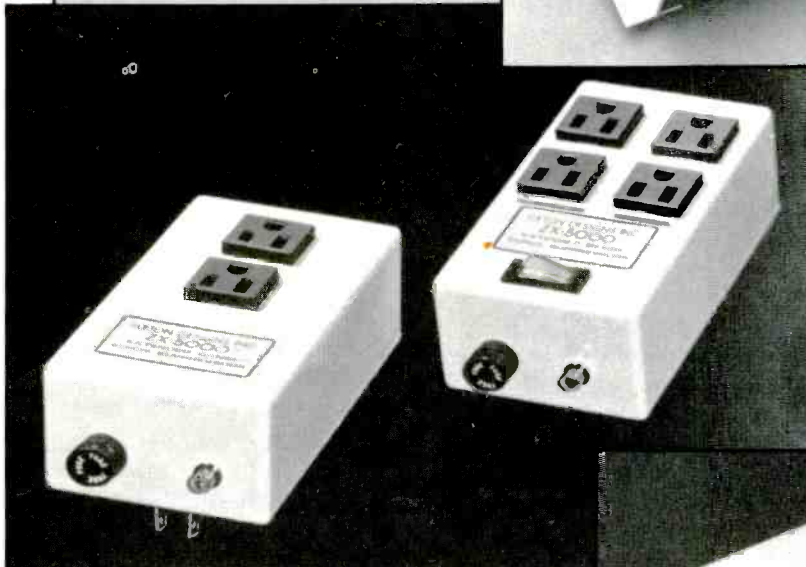
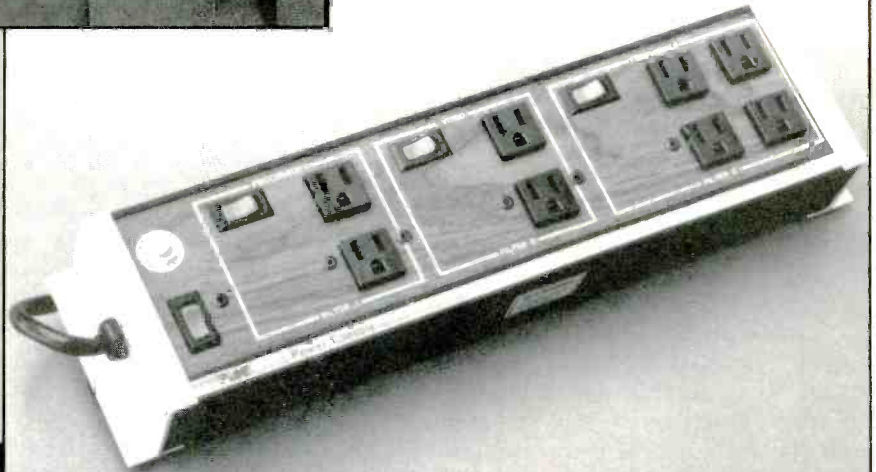

The ZX-5000 Extended Range surge/spike/noise suppressors by Sutton Industries, based upon a new hybrid protection circuit and filter bank system, have a rated energy dissipation of 450J, a rated power dissipation of over 4,500,000W in 100 μ s, a voltage withstand capability of 25,000V, a short term current rating of 20,000A, less than a 5ps response time, a clamping voltage of 195VP/138Vrms and a let-through voltage of 240VP/170Vrms.

The Datashield Model XT-300 backup power source by PTI Industries is a battery-operated, self-contained power generator that supplies even, uninterrupted ac power to a microcomputer in the event of a power drop or outage. In addition, it also provides surge protection, which filters and eliminates any voltage spikes or surges above 140V, as well as line noise from nearby appliances.



Continued from page 15

In less than a heartbeat, what used to be a +26 volt scan B+ source that supplies the tuner, IF, video, chroma circuit, suddenly surges to something over sixty volts. Should this happen, it doesn't take much imagination to realize what will happen to most (or all) of the solid state devices in all of the stages that are connected to the +26 volt source (which is now producing some + sixty volts)?

On the other hand, if the set had employed a 60 hz "sustaining" circuit for the purpose of supervising the LV regulator, the LV regulator would have immediately shut down as soon as the vertical output stage died, and no surge would have occurred on the +26 volt line.

The application is wide and varied.

Some sets employ as many as ten or eleven totally unrelated shut down circuits. Some of which may be used to shut down the horiz oscillator, others to shut down the LV regulator, and others to shut down the horiz driver. All ten circuits can come into play simultaneously, or they can also be activated on an individual basis.

Some LV regulator drive circuits are known to employ as many as seven totally unrelated shut down circuits, each independently activated by a totally unrelated event (i.e. a shorted video stage, an open vertical stage, excessive hi-voltage, excessive brightness, an inoperative ABL circuit, any type of a short in any circuit that relies on scan derived B+ voltage). A shorted LV regulator in turn may activate yet another shut down circuit that will saturate the base of the horiz driver transistor with positive voltage until all scan sources are dead, and the entire TV set is likewise dead.

Now, - - - let's analyze the above.

A TV set comes into your shop with a "dead set" symptom on its screen:

1. Did the Horiz oscillator die?
2. Did the horiz driver die?
3. Is the LV regulator in shut down?



**1800 TIMES FASTER
... THAN YOU**



**TRY ONE
IN YOUR TV SHOP
WITH NO 'UP FRONT' MONEY**

AS SOON AS YOU PUSH THE TEST BUTTON

<p>The defective component will light up in the Eliminator's generic schematic, A light will tell you whether that component is open or shorted, Another light will tell you what effect the defective component has had on the overall circuit (I.E. LV short, inductive short, no</p>	<p>start up, LV reg. shut down, horiz drive shut down, lost scan B+ source etc). An instruction will light up telling you how to verify the findings of the Eliminator by taking just one voltage reading at a "land mark" test point (without pulling the chassis).</p>
---	--

4 Did the LV regulator circuit simply die?

5. Did the horiz osc/driver die, or is one or both of them in shut down?

6. Could the safety capacitor be open?

7. Is the flyback defective, or is it a shorted vertical, video, R-B-G output stage, or the HV multiplier that is causing the flyback to "appear" to be defective?

8. Is the vertical output circuit functional?

9. Did the initial start up pulse occur?

10. Is the scan B+ "run" voltage present?

11. Is the flyback circuit open, shorted, is it simply not being driven, or is the flyback itself just defective?

12. Is the LV regulator working?

13. Is the circuit not working due to a defect in the horiz drive or LV regulator circuit, or is it in shut down due to a short or open condition in a circuit that utilizes scan derived B+?

14. Is the circuit defective?

15. Is the set in shut down?

16. Or could it be that it never really started up in the first place?

17. On the other hand, perhaps it started up; but did not receive any "run" B+ voltage.

The list of questions goes on and on.

In the case where the set is blowing a fuse, is it doing so because of a short in the LV supply? or, is it due to a short in the flyback related circuitry?

Allowing that a short, or, an open circuit almost anywhere in the TV set can cause either overall shut down, or failure to start up, or "failure to run" symptoms (which amount to nothing more than a dead set), and considering that an open or shorted primary LV supply will cause the same symptom, it's sometimes difficult to establish a starting point. It is **literally impossible** for any technician to establish **any** type of an organized troubleshooting routine, and **virtually impossible** for him to economically complete such repairs without an absolute stroke of luck with regards to "stumbling" over the defective part while chasing the elusive failure (usually in a circular motion).

Continued on page 19

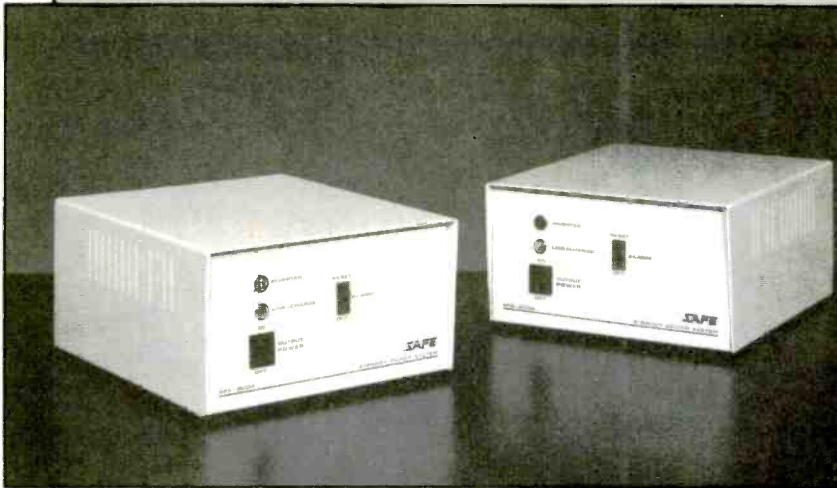

The Safe SPS200A and SPS400A from Safe Power Systems Inc. are backup power systems that turn on in less than one-third cycle, protecting the data and memory of a connected microcomputer, as well as providing built-in surge suppression. They provide power line synchronization, giving a smooth transition to standby power. The 200A unit, recommended for floppy disk applications, provides standby power for a minimum of 20 minutes. For larger, hard disk systems, the 400A provides standby power for a minimum of 10 minutes, giving an operator enough time to go through an orderly shutdown procedure.

The Power Commander II from Perma Power Electronics Inc. is a power control center that incorporates both computer and telephone line surge suppressors. The 5-outlet power control center, which features fingertip control for computer, monitor, printer and more, has a surge suppressor employing two 4-element, 2-stage filters in a coordinated circuit, using a combination of metal oxide varistors and silicon avalanche diodes that provides protection against both normal and common mode power surges.



The PowerMax from Panamax provides protection for microcomputers and word processing systems. It is effective in eliminating line disturbances (surges) or loss of power. The units come in 250W, 400W and 800W output and provide voltage surge, brownout, noise and power failure protection and a maintenance-free rechargeable battery for power continuity in case of power failure.

A final precaution

Before you purchase any kind of power protection device, it might not be a bad idea to do some research to make sure it will do what you need it to do reliably. And if you do get one of them and use it, unless you're 100% sure that it's designed to protect both you and your electronic equipment from close lightning strikes or when there are thunderstorms in the area, the old precaution about electrical and electronic equipment still applies: Turn it off, unplug it and leave it alone.

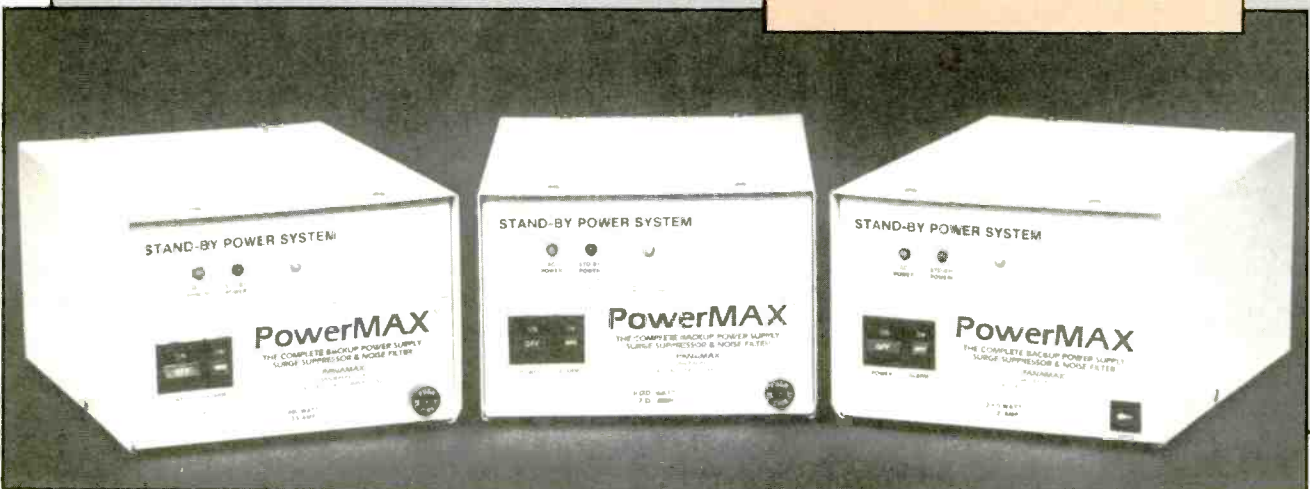

Continued from page 17

In order to effectively troubleshoot any bonifide start up, or shut down, or any type of flyback circuit related failure in a modern TV set, you would have to **simultaneously** determine whether the start up pulse occurred, whether the oscillator/driver circuits are functional, whether the scan B+ "run" voltage is being provided, whether any shorted or open conditions exist on the secondary side of the flyback, whether the LV supply is open or shorted, whether the LV regulator is working, and whether or not "how many" of the above circuits are capable of working with each other!

Unless you gathered every bit of the above information simultaneously, the problem or defect would come into play, and you would not be able to **ACCURATELY** gather any of it. In order to demonstrate this, consider a TV set that starts up with a burst of hi-voltage then promptly dies. Which circuit is defective, the osc/driver, the start up circuit, scan B+ circuit, LV regulator circuit, vertical circuit, primary LV supply, safety capacitor, flyback, or is it nothing more than a shorted R-B-G video output circuit? Could it be a shorted CRT?

The fact is, any of the above circuits could cause the exact same symptom that was given, and we defy any human technician to come up with any type of systematic method of separating the possibilities of failure. Like we said, unless you can gather **all** of the above information simultaneously, and do so during the very first one hundredth of one second of circuit operation, you will not be able to gather **any** of it, on **any** type of a systematic basis.

If you have been having problems with start up and shut down circuitry, at least now you know why. You should also be aware at this point that every technician who is working on them is also "donating" much of his time for the same reasons.

In order to solve the above problems once and for all, we at **DIEHL** designed a digital computer that does indeed gather all of the above information, plus some ten

times as much "other" information within the first one hundredth of a second of operation.

In the next one hundredth of a second it will compare everything that did, and everything that did **not** happen in the entire low voltage, hi-voltage, horiz osc/driver, LV regulator, start up, shut down, flyback transformer, and any circuit that relies on scan derived B+ (including external and internal HV multipliers and picture tube), including the vertical, video, R-B-G video output circuits (from a current consumption standpoint), then organize and discern all of the above with absolute 100% accuracy.

In the next one hundredth of a second, our latest diagnostic computer will tell you exactly and precisely which type of a circuit condition, or circuit failures exist. For example, it will tell you if the LV supply is open or shorted, if the LV regulator is open or shorted, if the main filter capacitor in the LV supply is open or shorted, if the pin cushion, H. yoke, centering diode, H. yoke discharge capacitor, or damper diode is open or shorted,

likewise for the primary winding of the flyback.

It will then tell you whether the initial start up circuit, horiz osc/driver, and scan derived "run" B+ source is open or shorted (including any rectifier, resistor, capacitor, or transformer in this circuit). It will pinpoint shorted horiz driver transistors. It will also pinpoint any open or shorted rectifier or filter capacitor in any B+ path (scan or otherwise). The Mark VII-E will also tell you if either the LV regulator or the horiz osc/driver is in shut down. Not only that, it will also tell you **why** it is in shut down.

If any type of a short or open exists in any portion of the flyback circuitry, it will pinpoint that condition.

In the event it encounters an open safety capacitor or damper diode, it will automatically "bridge in" its own substitution component, light a lite telling you that it has done so, then continue with its scan as though nothing were wrong regarding the safety cap or damper

Continued on page 21



WITH AN ELIMINATOR
There Is No Such Thing
... As A Dog



Phone
(806) 359-0329
And Try One Yourself

FOR START UP/SHUT DOWN PROBLEMS
OR ANY LV, HV, FLYBACK RELATED FAILURE

In any eight hour day, one Eliminator will accurately identify more defective components (ones that will actually repair the TV set), than any ten technicians who are presently working anywhere in the TV

service industry.
 (Even if it is being operated by an amateur)
 Rather than mumble to yourself
"IT CAN'T BE DONE"
 Why not try one in your own shop

Sources of power conditioning equipment

Acme Electric Corporation
125 S. Union St.
Olean, NY 14760
716-373-3255

Circle (140) on Reply Card

Advanced Electronics Systems Inc.
2005 Lincoln Way East
Chambersburg, PA 17201
717-263-5681

Circle (141) on Reply Card

BEHA Corporation
13191 56th Court, Unit 101
Clearwater, FL 33520

Circle (142) on Reply Card

CPS Electronics Inc.
4151-112th Terrace N.
P.O. Box 2460
Pinellas Park, FL 34290-2460
813-578-1600

Circle (143) on Reply Card

Clary Corporation
320 W. Clary Ave.
San Gabriel, CA 91776
818-287-6111

Circle (144) on Reply Card

Controlled Power
1955 Stephenson Hwy.
Troy, MI 48083
313-528-3700

Circle (145) on Reply Card

Current Technology Inc.
1400 S. Sherman, Suite 202
Richardson, TX 75081
214-238-5300

Circle (146) on Reply Card

Cuesta Systems
3440 Roberto Court
San Luis Obispo, CA 93401
805-541-4160

Circle (147) on Reply Card

Dranetz
P.O. Box 4019
Edison, NJ 08818-4019
201-287-3680

Circle (148) on Reply Card

Ecos Electronics Corporation
205 W. Harrison St.
Oak Park, IL 60304
312-383-2505

Circle (149) on Reply Card

Electronic Specialists Inc.
171 South Main St.
Natick, MA 01760
617-655-1532

Circle (150) on Reply Card

General Power Systems
1400 N. Baxter St.
Anaheim, CA 92806
714-956-9321

Circle (151) on Reply Card

Kalglo Electric
6584 Ruch Road
Bethlehem, PA 18017
800-524-0400

Circle (152) on Reply Card

Lakontek Inc.
2385 South Clinton Ave.
South Plainfield, NJ 07080
201-755-7680

Circle (153) on Reply Card

PMC Industries Inc.
9353 Activity Road
San Diego, CA 92126
619-695-3520

Circle (154) on Reply Card

PTI Industries
320 River St.
Santa Cruz, CA 95060
408-429-6881

Circle (155) on Reply Card

Panamax
150 Mitchell Blvd.
San Rafael, CA 94903
415-499-3900

Circle (156) on Reply Card

Para Systems Inc.
11425 Mathis St.
Suite 404
Dallas, TX 75234
214-869-1688

Circle (157) on Reply Card

Perma Power Electronics Inc.
5615 West Howard Ave.
Chicago, IL 60648
312-647-9414

Circle (158) on Reply Card

Philips ECG
100 First Ave.
Waltham, MA 02254
617-890-6107

Circle (159) on Reply Card

Pilgrim Electric Co.
105 Newtown Road
Plainview, NY 11803
516-420-8990

Circle (160) on Reply Card

Power Integrity Corporation
1840 Pembroke Road
Greensboro, NC 27429-0682
919-379-9773

Circle (161) on Reply Card

RCA Distributor and Special Products Division
200 Clements Bridge Road
Deptford, NJ 08096
609-853-2243

Circle (162) on Reply Card

Safe Power Systems Inc.
528 W. 21st. St.
Tempe, AZ 85282
602-894-6864

Circle (163) on Reply Card

Continued on page 22

ADVERTISEMENT

Our New Electronics Assembly Plant

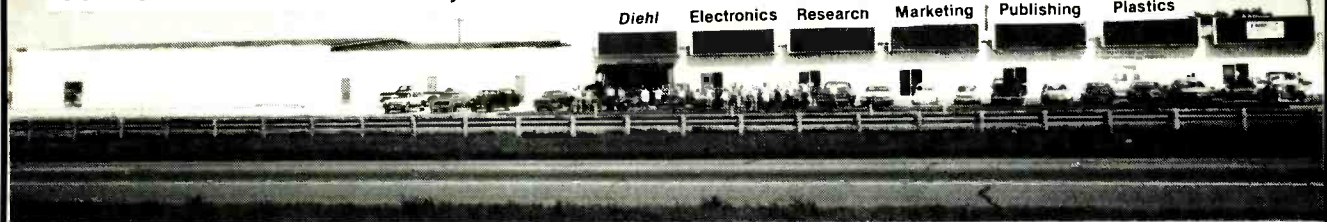

In August of this year, *Diehl* doubled its capacity to manufacture diagnostic computers. We would like to take this opportunity to

thank our 15,000 plus loyal customers who made it all possible. Without **Y O U**, we could not have survived.

Continued from page 19

diode. (without our computer, you would lose the horiz output transistor and perhaps the damper diode at the very first sign of an open safety capacitor).

Not only will our computer tell you the exact nature of the failure with regards to precisely which circuit has failed, and the condition that has been induced, it will also (in that same one hundredth of one second), tell you exactly **which** component in that circuit has failed.

In order to make absolutely certain that you do **not** think the previous sentence contained some sort of a typographic error, we will now repeat it.

Our new Mark VII-E Diagnostic Computer will pinpoint the exact component that has failed, and do so within one hundredth of one second of operation.

Furthermore, it will not only pinpoint the exact **nature** of the circuit failure, pinpoint the exact **component** that has failed, and tell you whether that component is now open or shorted, - - - it will also give you a brief **instruction** that will tell you how to **prove** beyond any possible doubt that the decisions made by the Mark VII-E are 100% correct with regards to which type of circuit condition exists, and exactly which component has failed. This instruction will in every instance tell you how to prove the findings of the Mark VII-E by measuring nothing more than the collector of just one "land mark" test point (i.e. the collector of any R-B-G video output transistor).

The mark VII-E works on any TV set that employs either an N-P-N transistor, or a single SCR as a horiz output device. No programming is required. Everything you need

comes with it. Almost no instructions are required. The top of its case houses an 8"x11" display panel which contains a generic schematic for LV, LV regulator, H. osc/driver, output, flyback, yoke, scan B+ circuits, etc., etc. All instructions are contained within the generic schematic, but not visible until they are illuminated by the VII-E.

As soon as you push the test button, the defective component will lite up amber, the circuit condition will lite up red, and the instruction will lite up yellow. As a result, the Mark VII-E may well be the only piece of major test equipment that you can take out of its box and immediately begin using (without reading anything), since it provides its own instructions as you go.

With regards to exactly which circuit has failed, and exactly what type of circuit condition exists, the Mark VII-E can **never** be wrong. As to exactly which component has failed, it may occasionally miss by no more than one or two components. If so, the TV set will pass the test that is given by the instruction. In this event, the next time you push the test button, the Mark VII-E will automatically "step" to the next lower "odds" circuit, lite the next likely suspect component, and a brand new instruction for proving or disproving the new "suspect" component. In almost no instance will you ever have to so much as look at more than three components. By the time the Mark VII-E has "stepped down" to its third odds circuit, it is greater than 99% accurate. The "odds of probability" are displayed on the front panel of the computer for each

individual finding.

To operate a Mark VII-E, simply plug the TV set into its female AC outlet (front panel), interface the horiz output device, push the test button, and read the generic schematic. If you hook it up wrong, the "hook up" light on its front panel will come on, and the Mark VII-E will shut itself and the TV set off until you correct the error.

For obvious reasons we call it the "**Eliminator**". If you earn your living repairing TV sets - - - You need one! They sell for only \$3,495⁰⁰ and are now available. Visa and Master Card welcome, short term/long term financing is available. With approved credit, we'll even let you try one in your own shop for fifteen days with no up front money. Call (806) 359-0329 for more information, or write **DIEHL** Industries, 6661 Canyon Drive, Amarillo, Texas 79110.

Diehl will pay \$100,000⁰⁰ to any technician, engineer, factory representative, or to any **group** of technical personnel, who can effectively compete against an eliminator with regards to speed and accuracy, no matter how much "other" test equipment they care to use, no matter how much it costs (We'll even give them two to one odds). This is a serious offer. If you or anyone you know would like to take us up on it, we will be pleased to send you an application to do so. When it comes to start up and shut down related circuitry, nothing on earth will compete with **DIEHL'S** Mark VII-E Eliminator. - - - Nothing! For that very reason, you truly need one.

**Wait till you see Diehl's Mark VII
VIDEO ANALYZER**

Circle (8) on Reply Card

Shape Magntronics Inc.
901 Dupage Ave.
Lombard, IL 60148
312-620-8394

Circle (164) on Reply Card

Sola
1717 Busse Road
Elk Grove Village, IL 60007
312-439-2800

Circle (165) on Reply Card

Sun Research, Inc.
Old Bay Road, Box 210
New Durham, NH 03855
800-443-1922

Circle (166) on Reply Card

Superior Electric Inc.
383 Middle St.
Bristol, CT 06010
203-582-9561

Circle (167) on Reply Card

Sutton Designs Inc.
Computer Security Division
300 N. Tioga St.
Ithaca, NY 14850
607-277-4301

Circle (168) on Reply Card

Technipower
P.O. Box 222
Commerce Park
Danbury, CT 06810
203-748-7001

Circle (169) on Reply Card

Tripp Lite
500 N. Orleans
Chicago, IL 60610
312-329-1777

Circle (170) on Reply Card

Tycor Electronic Products Ltd.
6107 Sixth St.
SE Calgary, Alberta T2H 1L9
Canada
403-259-3200

Circle (171) on Reply Card

Ultima Electronics
21 Central Drive
Farmingdale, NY 11735
516-752-0144

Circle (172) on Reply Card

condition causes a problem with consumer electrical or electronic equipment will depend on the level of the overvoltage and the nature of the equipment. This is a rare condition, but if it occurs it can cause stress on equipment and may result in premature failure.

Sags—This is a drop in line voltage for one or a few cycles, and may be caused by the turn-on of equipment that consumes large quantities of power, such as heavy industrial equipment. Unless sags are prolonged or especially deep, they are probably insignificant, probably won't even be noticed.

Surges—These are increases in line voltage over the nominal value occurring for one or a few cycles and may be caused when heavy equipment is turned *off*. As with sags, ordinarily these will not cause problems unless they are large or prolonged.

Dropouts—A dropout is a complete loss of power that exists for less than one cycle. Most household electrical/electronic equipment will not notice these, but personal computers or computer-based devices may be disrupted.

Transients—Transients such as voltage spikes may be impressed on the power line by a number of sources. The inductive kickback when a motor is turned *off*, in the industrial plant down the road or in your home, might send a spike of a few volts or hundreds of volts down the wire that could cause a personal computer or a microcomputer-based product to malfunction momentarily, or even cause significant damage to some of the components and premature failure of the unit.

The effects of power line problems

Most of these power line problems do not pose serious threats

to consumer electronics equipment, because most consumer electronics equipment is designed to tolerate some degree of input voltage variation. Unless they're excessive, undervoltages, overvoltages, sags and surges will probably not even be noticed by televisions, stereos and other electronic devices found in the home.

With today's sophisticated computer-based equipment, the power line problems most likely to cause trouble are the brief, abrupt fluctuations in line voltage: dropouts and transients.

In the case of a dropout, the absence of power is so brief that there probably won't be any indication that anything happened to the power. If there's a microcomputer, or microcomputer-based equipment connected to the line, though, it may exhibit some strange behavior; possibly turn out some erroneous results. If, for example, a dropout occurred resulting in a too-low level of voltage on the logic circuits during a computer operation involving writing to memory, the result might be some bad data in the memory, and possibly crashing of the program.

A transient is capable of causing anything from no problem to total failure of the system, depending on the nature and magnitude of the transient and the degree of sensitivity of the device to transients.

A very brief, low value of transient might not even be noticed. A somewhat more powerful transient might appear to the system to be a logic pulse and result in erroneous bits being placed into memory. A little more intensity and a transistor might suffer a slight amount of damage, starting it on its way to eventual failure. If the transient is of sufficient intensity, any modern electronics device with voltage-sensitive components that happens to be connected to the line and turned *on* might be severely damaged.

Leader of the Pack

Avoiding power line problems

Unless you use a power line monitor, you probably won't know for sure whether the utility power coming into your house is carrying with it damaging transients. Unless you are certain that it is not, you probably will be correct in assuming that it is. That being the case, it really makes sense to protect any delicate electronics equipment: television, VCR, stereo, computer, with some form of transient protection.

Unfortunately, selecting a power protection product is not as easy as it sounds. There is a broad range of devices ranging from spike suppressors that cost from \$20 to \$100 up to uninterruptible power supplies that may cost several hundred dollars. To make matters worse, some of the products on the market are of limited effectiveness: They may keep low-energy transients out of your equipment but allow a lot of the energy from higher-energy transients through to damage your equipment.

Another problem sometimes encountered with transient protection products is that, in some cases, the protection unit itself may be damaged by a powerful transient, and unless there is some method of indicating this situation, you may be relying on protection that no longer exists, a situation that's worse than having no protection device at all.

Adding in protection

In some cases, you might prefer to incorporate transient suppression into the unit you wish to protect rather than install a plug-in suppressor, say because you might move the protected device around and leave the suppression device where it is. Or, if you want to be doubly safe, wear belt and suspenders so to speak, you might want to do both.

Philips ECG, which offers its own plug-in voltage surge suppressors, such as the EMF-2 (two prong) and EMG-3 (three prong) single-outlet units, the EMF-33 3-outlet unit and the EMF-315 Power Pure voltage surge and noise protector, also mentions the possibility of adding suppression to consumer electronic products.

ECG's periodical "Counter Points," Vol. 8 No. 2, contains some suggestions on putting transient suppression components right inside the product to be protected. Specifically, they suggest placing a MOV across the ac line after the fuse, the largest MOV that will fit, with an ac voltage rating of 150V. Another suggested precaution is to place a thermal cutout rated for 77°C in series with the line and tape it to the MOV so that if the MOV becomes hot from handling repeated surges, the circuit will open and let you know something's wrong.

ES&T *inc*



MCM

ELECTRONICS

In every field and every race there's always someone who breaks from the pack and leads the way.

When it comes to catalogs, that leader is MCM Electronics. And when it comes to service and repair work — that leader can be YOU!

Our newest catalog is your ticket to ride. So, be a leader! Call TODAY for your FREE copy — there's no obligation to buy.

TOLL-FREE 1-800-543-4330

(In Ohio call 1-800-762-4315)
(In Hawaii or Alaska 1-800-858-1849)

858 E. Congress Park Drive • Centerville, Oh. 45459



MCM ELECTRONICS
A PREMIER Company

Source No. ES-15

Circle (9) on Reply Card

Why do components fail?

By Victor Meeldijk

One obvious reason that components fail is that they just wear out. But there are many other causes, including inadequate design, careless handling and disregard of manufacturer recommendations, that you should take into account during troubleshooting.

Troubleshooting and subsequent failure analysis of system malfunctions often identifies the problem as an individual component failure. Besides random failures and manufacturing defects, the failure may have been caused by an incorrect application (by either system or component manufacturer), improper device handling (besides those caused by electrostatic discharge damage) or failure to follow manufacturer-usage recommendations. Some actual case histories follow.

Victor Meeldijk is Reliability and Maintainability Engineering manager, Diagnostic Retrieval Systems, Oakland, NJ.

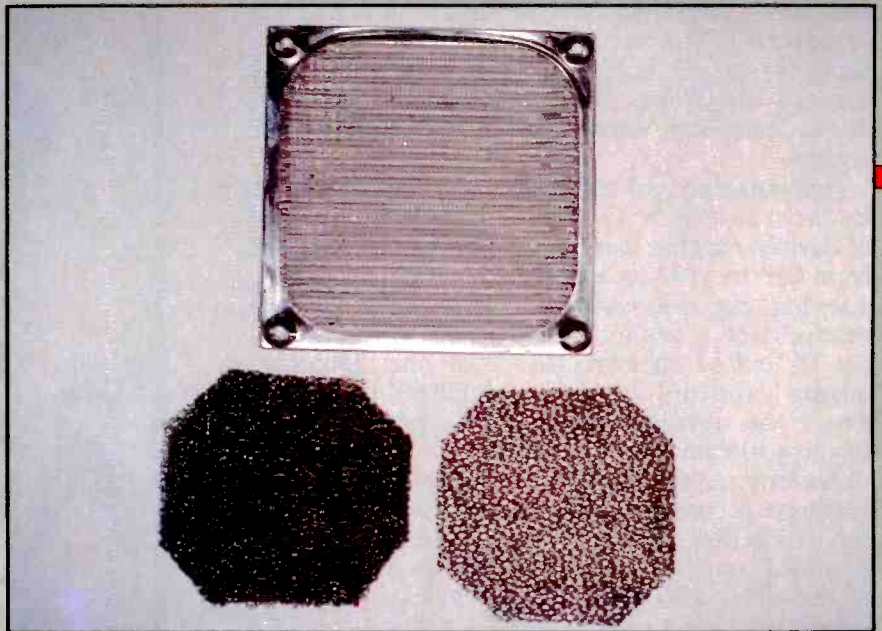

Figure 2. These fan filters are typical of those being used.

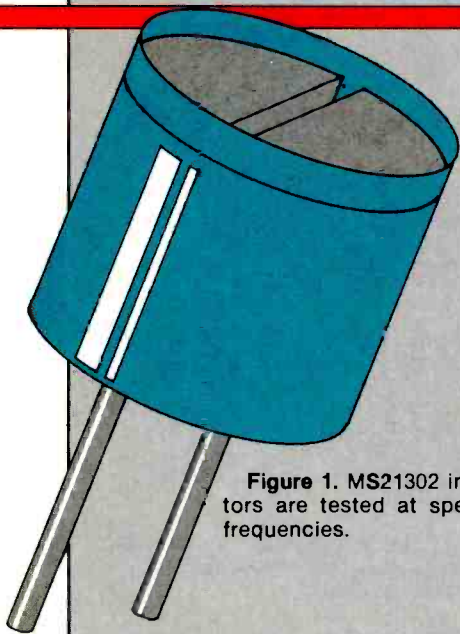

Figure 1. MS21302 inductors are tested at specific frequencies.

FOAM FILTERS

	WITHOUT FILTER	40PPI-1/4 THK	20PPI-1/4 THK	10PPI-1/4 THK
ROOM AMBIENT TEMPERATURE	71°	73°	75°	77°
EQUIPMENT AIR TEMPERATURE	81°	97°	94°	93°
TEMPERATURE RISE	10°	24°	19°	16°

NOTE: The more pores per inch, the greater the pressure drop. Density of material is not related to pore size.

TABLE 1. Temperature measurements (in °F) on a unit showing the differences in effect with and without fan filters, and according to PPI.

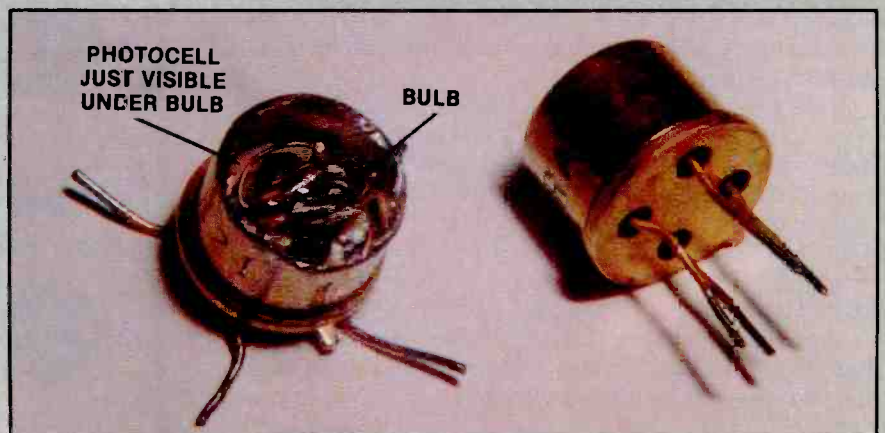

Figure 3. This optoisolator has an incandescent bulb design.

Application problems

Inductors per military specification MS21402 are specified and tested at specific frequencies. One device, for example, has an inductance range from $900\mu\text{H}$ to $1,100\mu\text{H}$ at 0.790MHz . At frequencies of between 48kHz and 96kHz , it was discovered the range varied from a low of $955\mu\text{H}$ to a high of $1,148\mu\text{H}$ at 48kHz to a range of $941\mu\text{H}$ to $1,164\mu\text{H}$ at 96kHz . The inductance range, therefore, shifted upwards at the lower frequency usage range.

Fan Filters

Fan filters usually are taken for granted and specified at the end of a design project, without thought to the serious problems that may arise. Figure 2 shows typical fan filters, both metal and foam type. Depending on the pores per inch (PPI) of the material used, fan filters can cause a significant difference in ambient temperature vs. internal equipment air temperature. Some typical measurements taken on a piece of electronic equipment are shown in Table 1. Clearly, the porosity (and thickness of the filter material selected) influences equipment internal temperature rises.

Optoisolators

Random vibration, per Navy material specification (NAVMAT) P-9492, may be specified on Navy procurement contracts. This specification calls for random vibration at specified levels.

Circuit cards tested to these vibratory levels experienced optoisolator failures. Failure analysis of the parts revealed that the design used an incandescent bulb and photocell (Figure 3) with the bulb filament opening due to the vibratory exposures. A replacement solid-state optoisolator, using a LED, was recommended by the device manufacturer.

Figure 4. These photos show three views of a hybrid voltage regulator with failed pass transistor (darkened area).

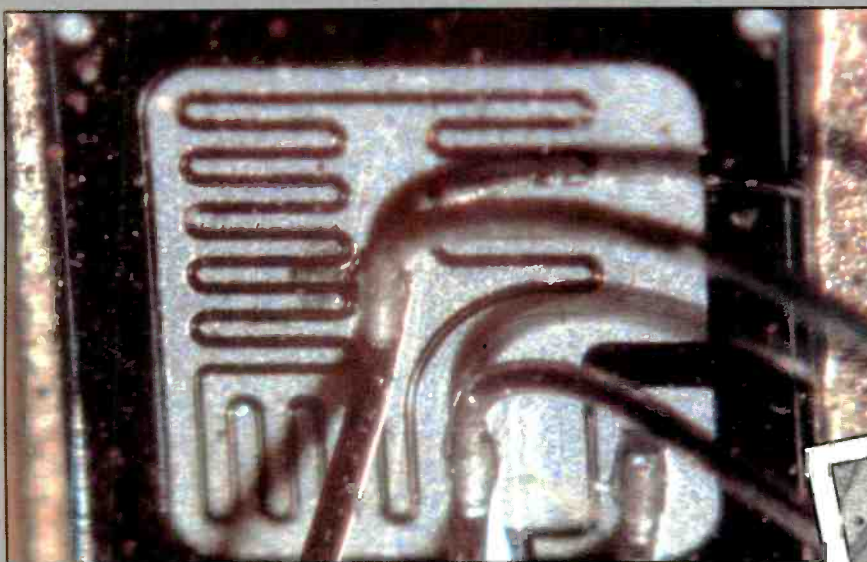

THIS COLOR CLOSEUP SHOWS THE AREA OF FAILURE



DAMAGED AREA IN RELATION TO THE OTHER COMPONENTS



A GREATLY ENLARGED VIEW OF FAILED AREA

Figure 5. Here is an indicator light with plastic lens.

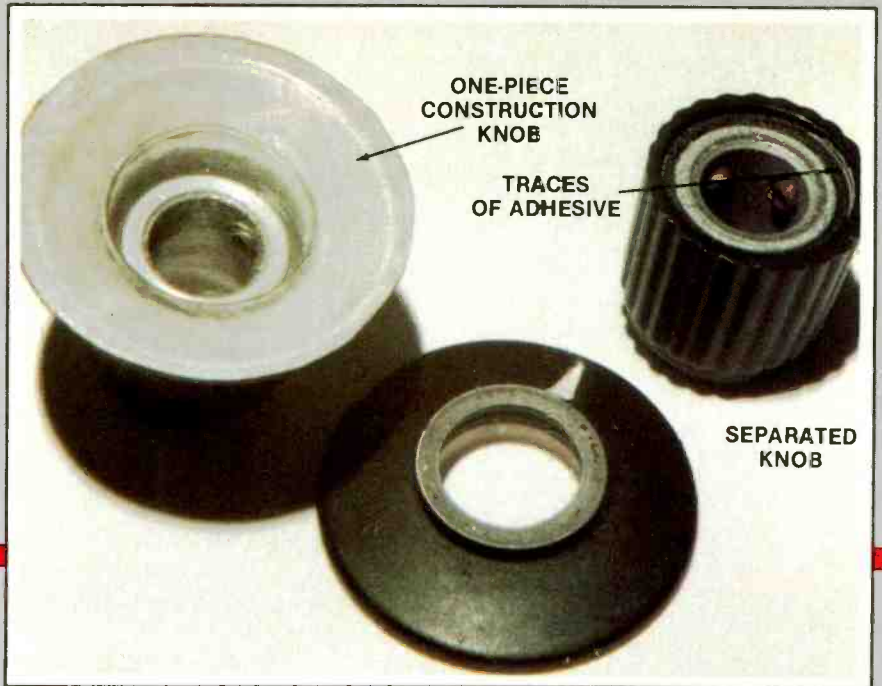
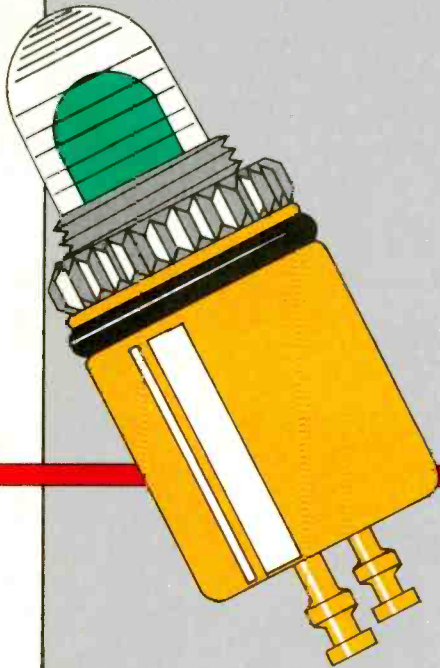

Figure 6. Adhesive problems cause skirted control knobs to separate.

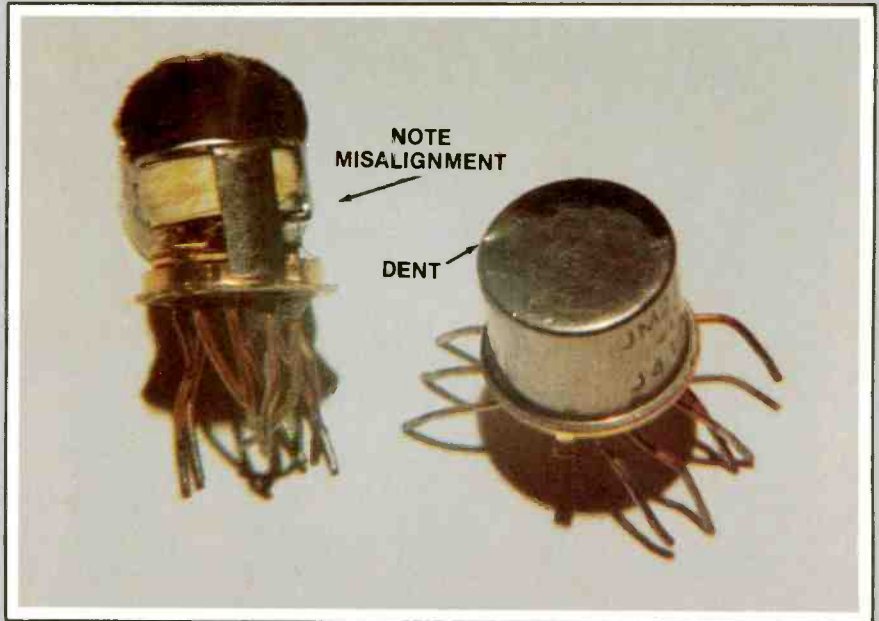

Figure 7. Improper handling has damaged this TO-5 can relay.

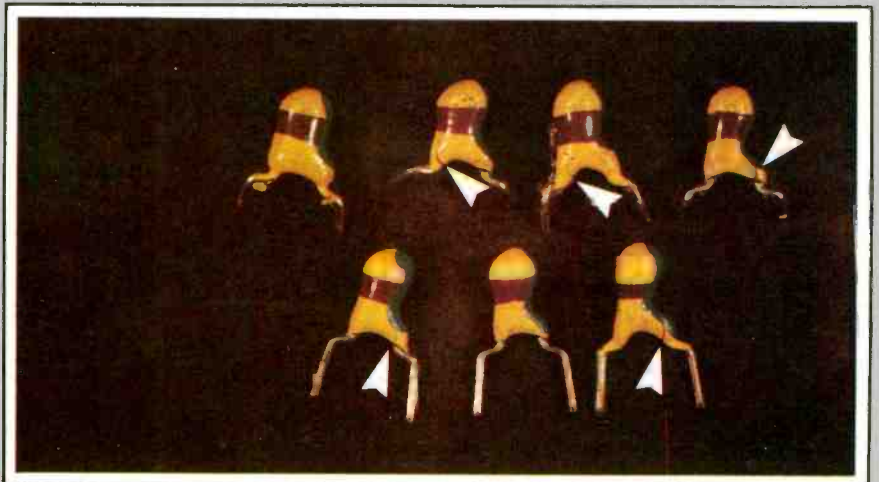

Figure 8. Arrows indicate cracks in the epoxy body of tantalum capacitors.

Voltage regulators

A hybrid voltage regulator used on an unregulated output of a power supply, which supplied voltage to a set of circuit card assemblies, was failing at a high rate. Failure analysis found that the regulator pass transistors were overstressed due to an excessive input/output voltage differential. It was discovered that during system testing part of the regulator's load would be removed, causing the unregulated supply output to rise, exceeding the input/output capability of the regulator. Figure 4 shows the pass transistor overstress condition.

Adhesives

Although not a serious problem, it was noted that some indicator light lenses were becoming loose (Figure 5). The manufacturing history of the device revealed the manufacturer had changed the lens material from acetate butyrate to a polycarbonate plastic. The adhesive used was inappropriate for this change, resulting in the loosened lens.

Another adhesive problem concerned a skirted control knob. The knob required backlighting of the skirt pointer and the manufacturer elected to combine a black molded knob with a transparent skirt.

Field usage resulted in the skirt separating from the knob. This would cause erroneous setting indications because the skirt pointer would not move as the knob was rotated. Uniform adhesive application material strength appeared to be the problem. Figure 6 shows a failed knob and a similar one made of a transparent material painted black: a 1-piece construction.

Device handling problems

PC Card relays

Figure 7 shows a TO-5 can relay. These units are extremely compact and there is little space between the top of the relay and the case. A depression on the top of the TO-5 can, caused either by the placement of one circuit card on top of another, or by dropping the relay, resulted in the relay misalignment shown.

Capacitors

Common components such as dipped tantalum capacitors also can be damaged easily. The units shown in Figure 8 have cracks in the encapsulating epoxy that were caused by forcibly spreading the device leads during PC card insertion. These cracks can allow moisture to penetrate the units and lead to intermittent operation. The cracks also provide a crevice that could trap particulate matter leading to a long term corrosion failure mode.

SCOPE PRICE BREAKTHROUGH!

New B&K-PRECISION Dual-Trace 20MHz Scope... \$440!!

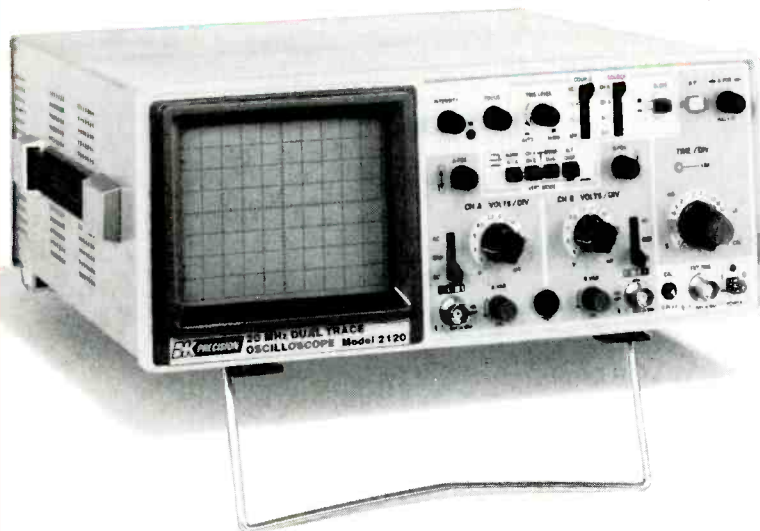

Now you can own a professional quality 20MHz, dual-trace scope for under \$450. Best of all, it's a full featured instrument, from B&K-PRECISION—famous for quality, dependable products.

Compare these outstanding features, then compare price!

- Dual or single trace operation • 2mV/div sensitivity
- 20MHz response at a true -3dB • AUTO/NORM triggered sweep operation with AC, TVH, TVV and Line coupling
- Calibrated 18 step timebase with x10 magnifier • X-Y operation • Bright, sharp rectangular CRT with P31 phosphor
- Front-panel trace rotation control • Tilt stand and soft handle • Selectable +/- slope • Built-in calibration source
- Compact low-profile design.

For immediate delivery, contact your local B&K-PRECISION distributor or call B&K-PRECISION today.

B&K-PRECISION DYNASCAN CORPORATION

6460 West Cortland Street • Chicago, Illinois 60635 • 312/889-9087
International Sales, 6460W Cortland, 1 St. Chicago, Illinois 60635 • Canadian Sales, Atlas Electronics, Ontario
South and Central American Sales, Empire Exporters, Plainview, NY 11803

Semiconductor devices

Everyone should be well aware of the sensitivity of electronic components to electrostatic discharges. Not only will devices fail immediately when exposed to these discharges, but they may be weakened and fail later during field usage. DOD-STD-1686 and Military handbook 263 are excellent reference materials to set up procedures to prevent electrostatic discharge damage to components and systems.

Cleaning fluids, or even some conformal coatings, can damage component materials. This often leads manufacturers to include warnings in their specification data. Not following these recommendations can lead to early device failure.

Switches

Devices that are not sealed, such as some switches, can become intermittent or freeze because of flux, cleaning solvents or conformal-coating contamination. The switch shown in Figure 9 became frozen due to conformal-coating material entering the unit.

Capacitors

Aluminum electrolytic capacitors are susceptible to corrosion caused by halogenated hydrocarbon cleaning solvents (Table 2 lists safe and unsafe solvents). The solvents penetrate the elastomer end seals of the capacitor, resulting in a long-term corrosion failure mode, the degree of which is dependent upon operating time, temperature and applied voltage. Excessive dc leakage, electrical open circuits or internal gassing are the failure symptoms. Field failure rates can be 20% or higher. Figures 10 and 11 show anodic corrosion and a pushed-out end seal caused by internal gassing.

Epoxy end seals are recommended (Figure 12) with exposure time to any unacceptable solvents limited to less than two minutes to prevent degradation of the epoxy barrier. As with the tantalum capacitor example, care should be exercised during device handling to prevent damage to the epoxy seal.

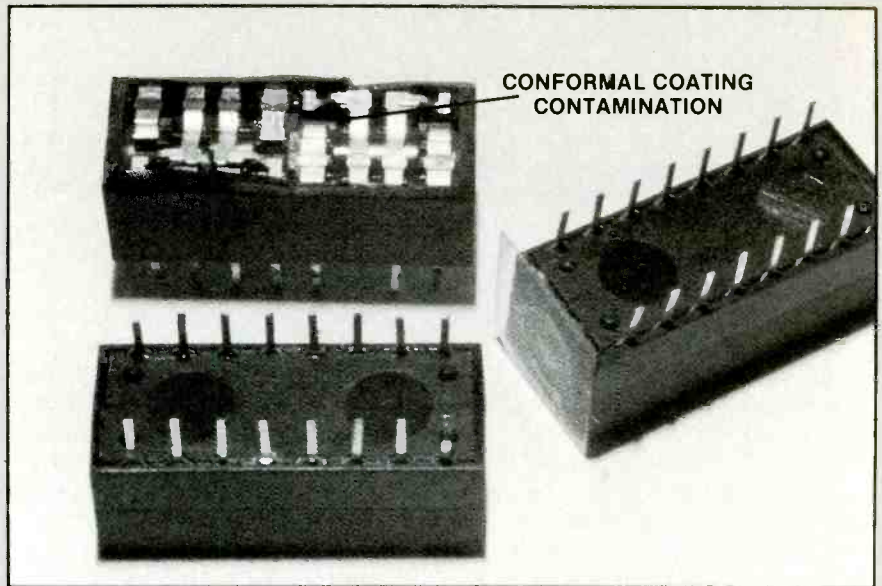

Figure 9. This switch shows corrosion damage from contamination by conformal coating material.

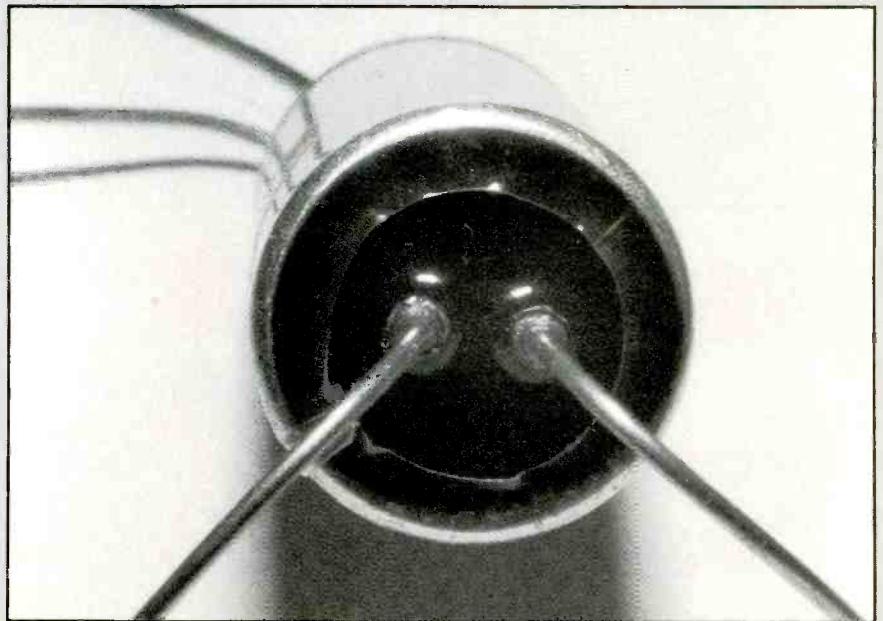

Figure 10. Epoxy seals may be exposed less than two minutes to unacceptable solvents, to prevent degradation of the epoxy barrier.

SAFE (ACCEPTABLE) CLEANING SOLVENTS

ACETONE	METHYL ALCOHOL
TOLUOL-HEXANE-ETHYL-ACETATE	MINERAL SPIRITS
BUTYL ALCOHOL	PROPYL ALCOHOL
ETHYL ALCOHOL	XYLENE
LACQUER THINNER	

UNSAFE (UNACCEPTABLE) CLEANING SOLVENTS

CARBON TETRACHLORIDE	METHYLENE CHLORIDE
CHLOROFORM	PERCHLOROTYLENE
CHLOROTHENE	TRICHLOROETHANE
FREON	TRICHLOROETHYLENE

TABLE 2. Examples of safe and unsafe cleaning solvents to use with aluminum electrolytic capacitors.



Figure 11. Here, there is anodic corrosion of an aluminum capacitor.

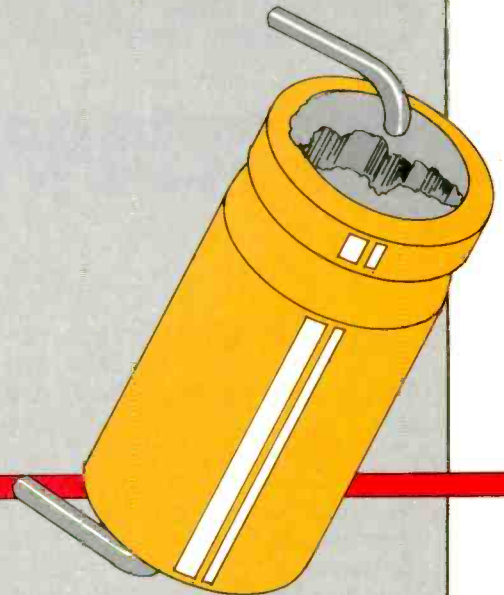
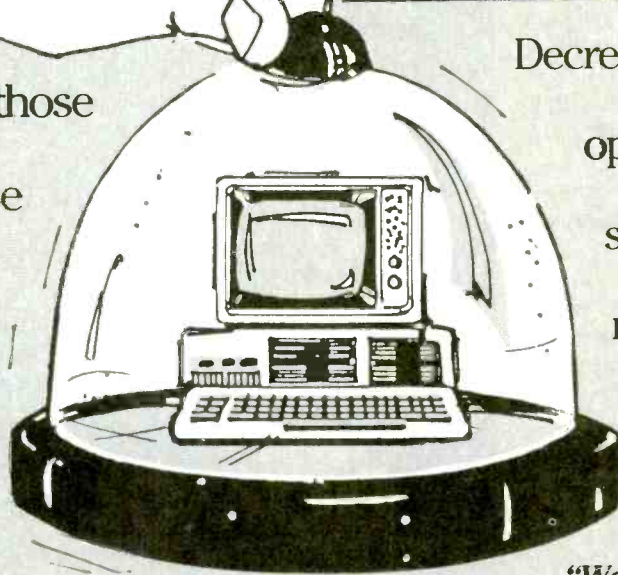

Figure 11. Internal gassing has pushed out the end seal of this aluminum capacitor, a failure symptom. **ES&T**

Protect Your Investment

Tycor® will help you put the lid on those aggravating power problems that cause 98% of all micro-processor based equipment malfunctions.

Two of the largest third party Maintenance Groups, in field studies, have proven that, with the use of **TYCOR® AC POWER LINE FILTERS**, service calls decreased by 70% with virtually no board repairs necessary.



Decrease your equipment's downtime, increase operator efficiency and morale, reduce large spare parts inventory, eliminate costly reboots and the need for dedicated-lines.

TYCOR® ELECTRONIC PRODUCTS LTD.

6107 - 6th Street S.E., Calgary, Alberta,
Canada T2H 1L9
(403) 259-3200 Toll Free 1-800-661-9263

*"We didn't invent Clean Power,
We Merely Perfected It."*

Circle (11) on Reply Card

Test your electronic knowledge

By Sam Wilson

The questions this month are taken from the July 1986 and August 1986 issues of *ES&T*. Are you keeping up with the technology?

1. By separating the camera head (lens and charge-coupled device image sensor) from the rest of the camera's electronics, engineers have developed a video camera device that's roughly the size of a human

- A.) neck.
- B.) wrist.
- C.) thumb.

2. As a transistor parameter, gamma would normally be used in the design of

- A.) oscillator circuits.
- B.) common emitter audio amplifiers.
- C.) follower circuits.
- D.) RF amplifiers.

3. The rubberlike plastic interface material that is used to connect components to a printed circuit board without soldering is called

4. Which of the following is a likely result of 19kHz pilot leakage in an FM stereo receiver?

- A.) Overload AGC
- B.) Poor low frequency response
- C.) Loss of afc
- D.) Speaker overload

5. Referring to the receiver in an audio system, the manufacturer may give a *usable sensitivity* rating of $1.5\mu\text{V}$ or $2\mu\text{V}$. Which of the following is true?

- A.) The higher the number, the better the receiver.
- B.) The lower the number, the better the receiver.

6. Referring, again, to the receiver in an audio system, a *db quieting* is preferred over *usable sensitivity* because it

A. is the usable signal rating.

B. is the signal at which the receiver can maintain automatic frequency control.

7. For cleaning the upper cylinder unit in a VCR,

- A.) use an emery board.
- B.) use head cleaning sticks.
- C.) soap and water is best.

8. Most microcomputers are

- A.) CMOS.
- B.) TTL.
- C.) ECL.
- D.) RTL.

9. For a quick check of an audio amplifier for frequency response, A.) a sawtooth waveform can be used instead of a square wave.

B.) a sawtooth waveform cannot be used instead of a square wave.

10.) A TVRO antenna mount that allows the user to receive signals from all satellites in the geosynchronous, or Clarke, orbit simply by turning the dish on its axis is called

- A.) altazimuth mount.
- B.) polar mount.

The answers are on page 65.

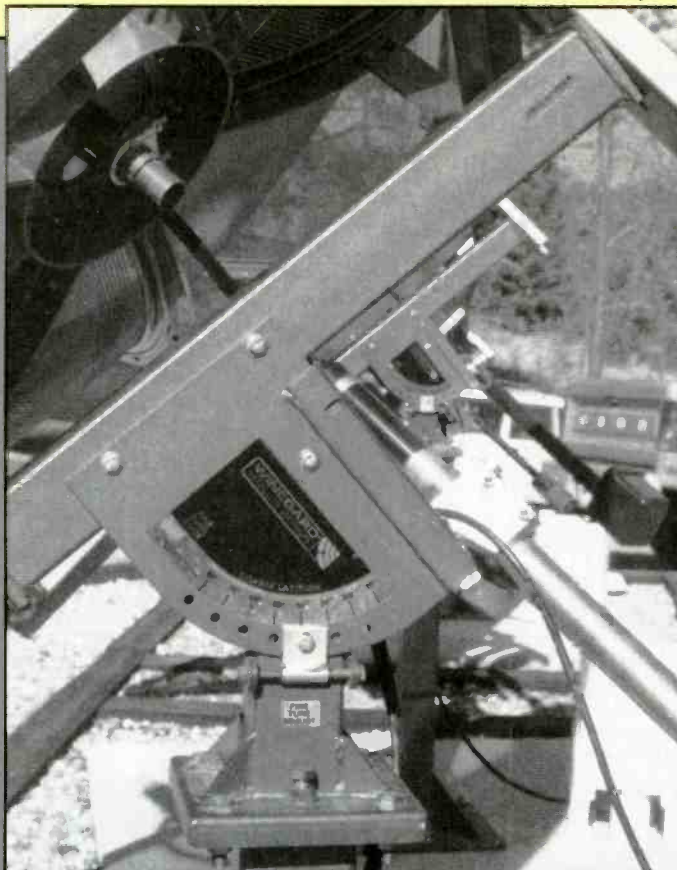

The other portions of this schematic may be found on other Profax pages.

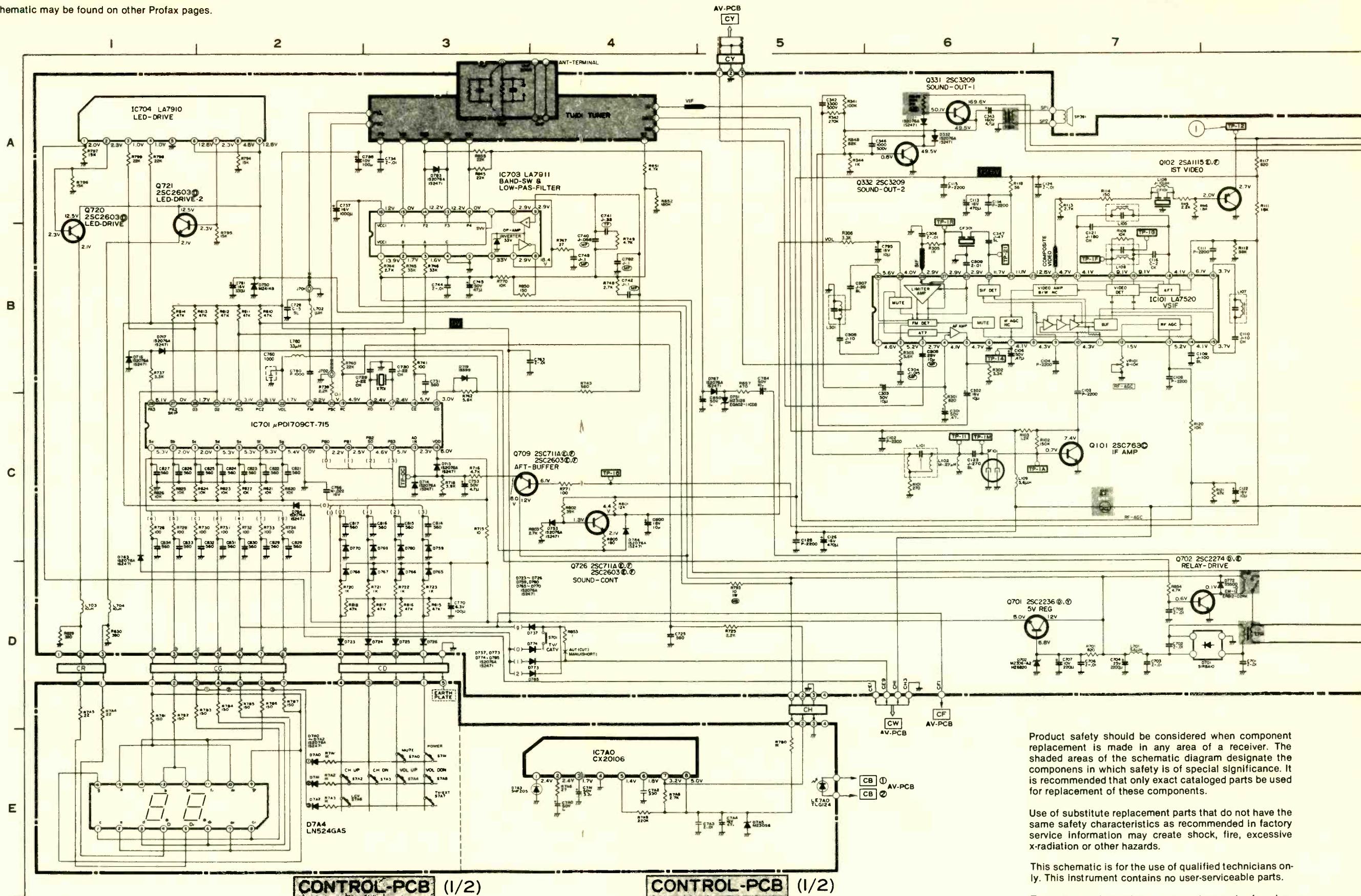

Product safety should be considered when component replacement is made in any area of a receiver. The shaded areas of the schematic diagram designate the components in which safety is of special significance. It is recommended that only exact cataloged parts be used for replacement of these components.

Use of substitute replacement parts that do not have the same safety characteristics as recommended in factory service information may create shock, fire, excessive x-radiation or other hazards.

This schematic is for the use of qualified technicians only. This instrument contains no user-serviceable parts.

The other portions of this schematic may be found on other Profax pages.

RCA
B&W TV basic service data2093

GE
14" portable color TV2094

Schematic No.

Product safety should be considered when component replacement is made in any area of a receiver. A star next to a component symbol number and a star(s) on, or surrounding schematic symbols designate components that have special safety characteristics. Only the exact manufacturer's specified parts should be used as replacements. Use of substitute replacement parts that do not have the same safety characteristics as recommended in factory service information may create shock, fire, excessive x-radiation or other hazards.

This schematic is for the use of qualified technicians only. This instrument contains no user-serviceable parts.

The other portions of this schematic may be found on other Profax pages.

Product safety should be considered when component replacement is made in any area of a receiver. A star next to a component symbol number and a star(s) on, or surrounding schematic symbols designate components that have special safety characteristics. Only the exact manufacturer's specified parts should be used as replacements. Use of substitute replacement parts that do not have the same safety characteristics as recommended in factory service information may create shock, fire, excessive x-radiation or other hazards.

The other portions of this schematic may be found on other Profax pages.

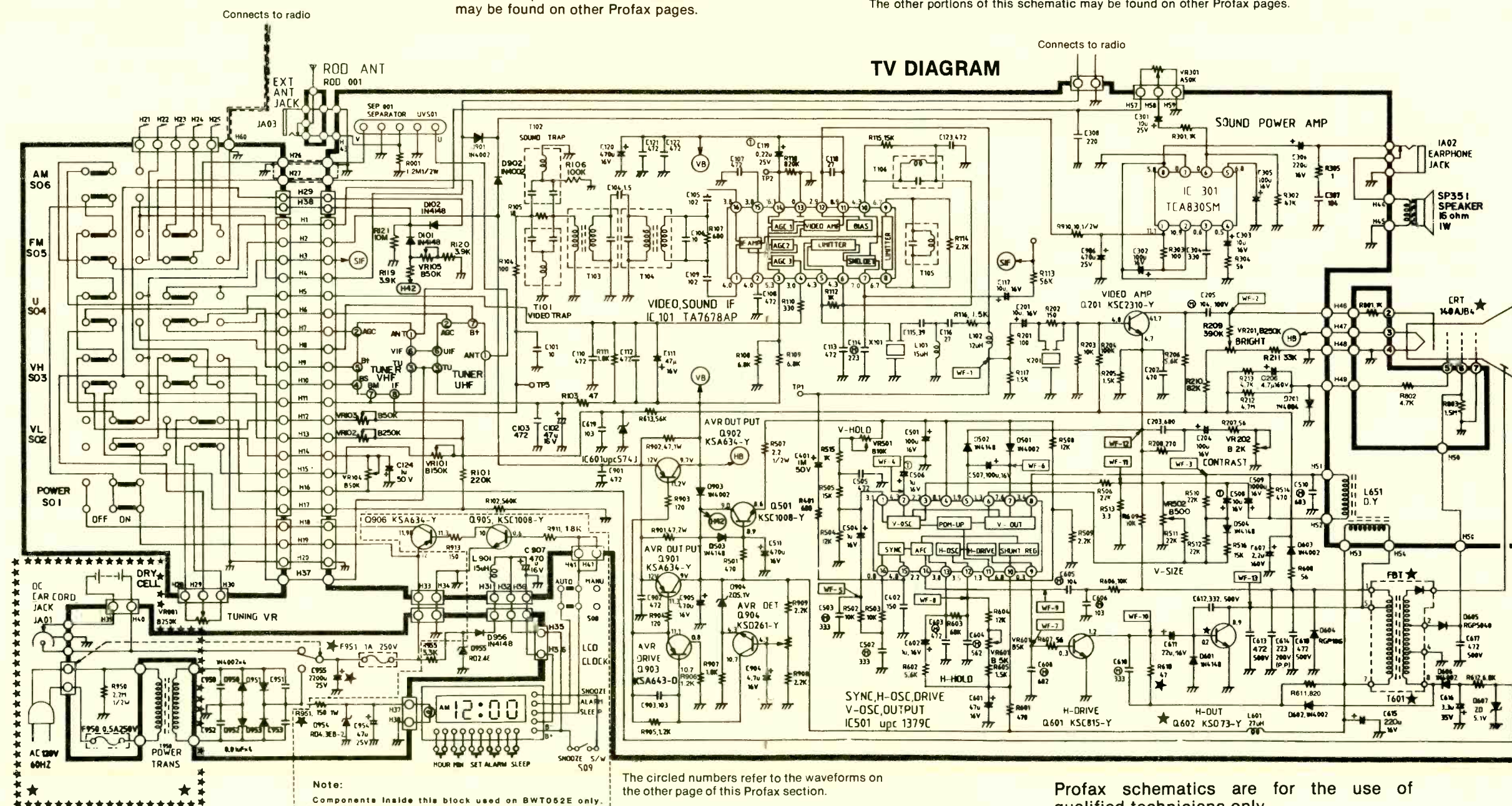

The circled numbers refer to the waveforms on the other page of this Profax section.

Profax schematics are for the use of qualified technicians only.

GE
 14" portable
 color TV

8 9 10 11 12 13 14

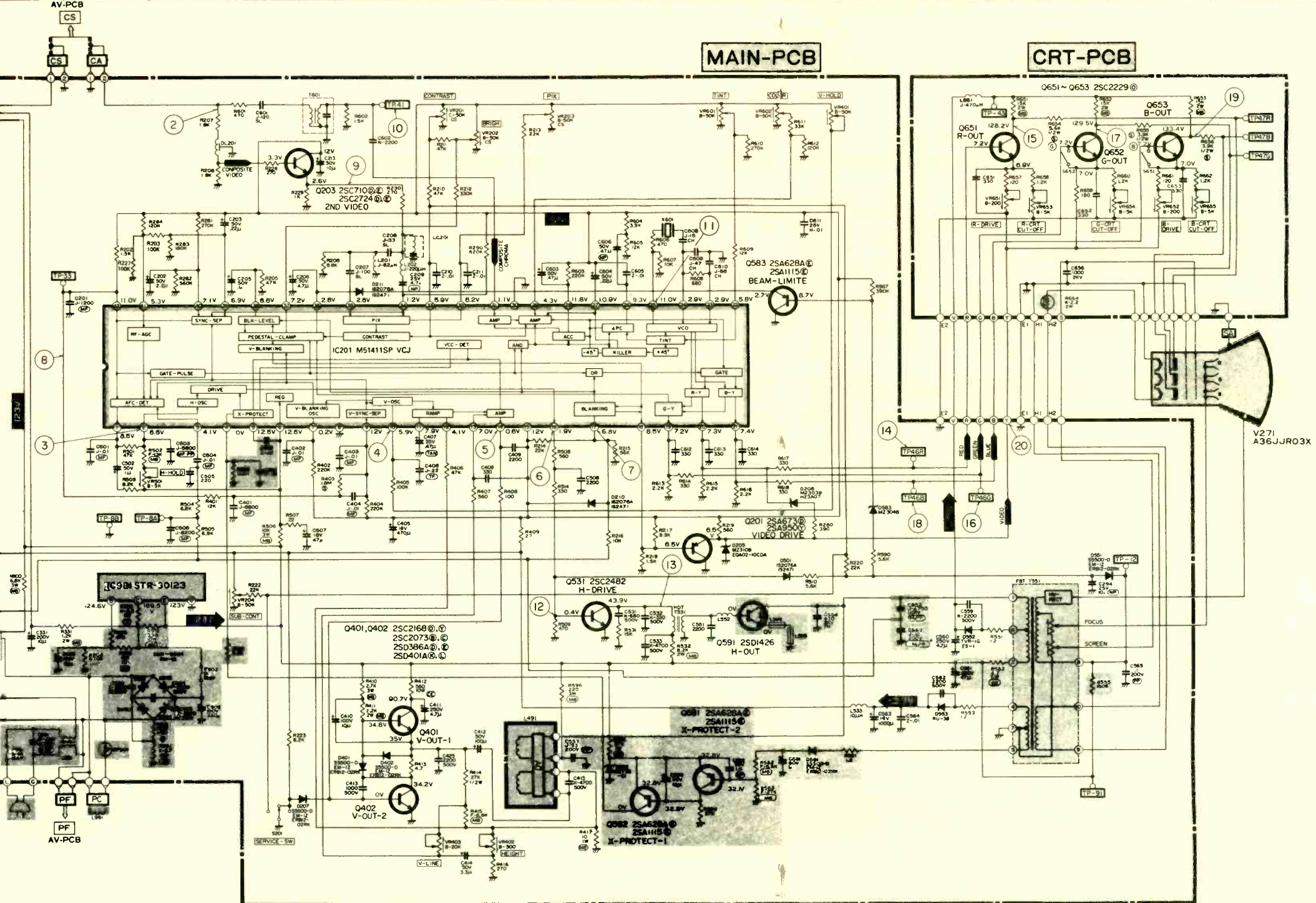

Product safety should be considered when component replacement is made in any area of a receiver. The shaded areas of the schematic diagram designate the components in which safety is of special significance. It is recommended that only exact cataloged parts be used for replacement of these components.

Use of substitute replacement parts that do not have the same safety characteristics as recommended in factory service information may create shock, fire, excessive x-radiation or other hazards.

This schematic is for the use of qualified technicians only. This instrument contains no user-serviceable parts.

The other portions of this schematic may be found on other Profax pages.

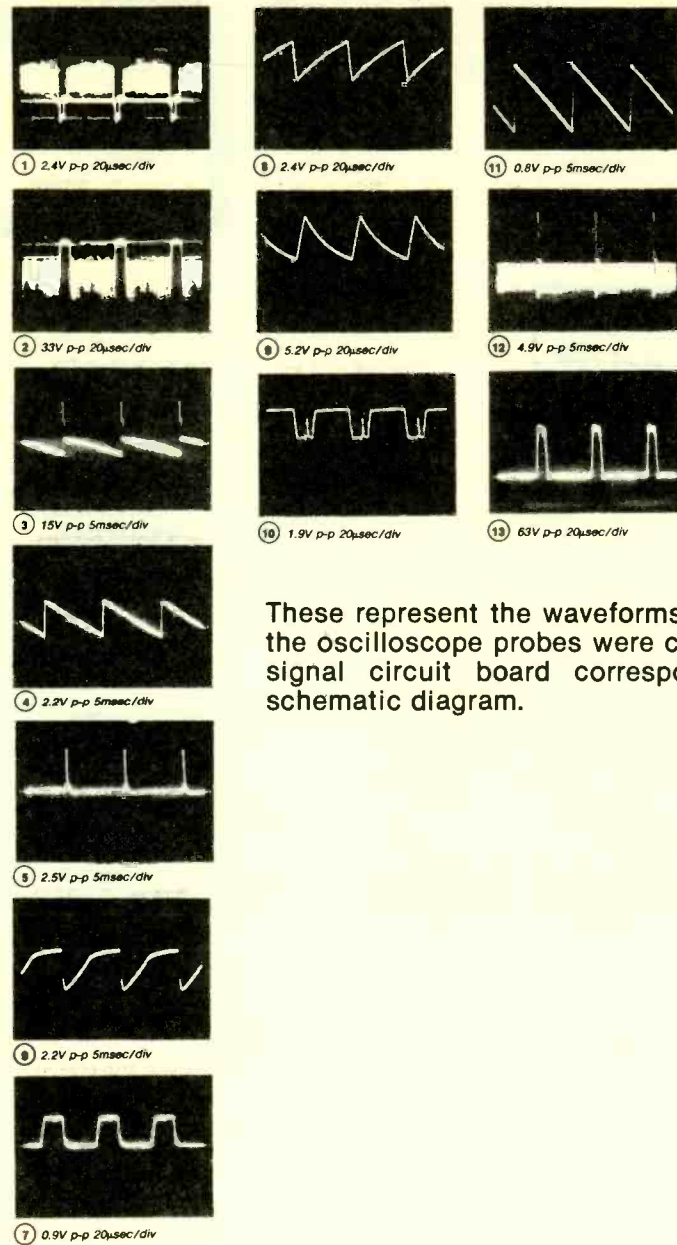

These represent the waveforms on the oscilloscope screen when the oscilloscope probes were connected to the test points on the signal circuit board corresponding to the numbers on the schematic diagram.

Product safety should be considered when component replacement is made in any area of a receiver. A star next a component symbol number and a star(s) on, or surrounding schematic symbols designate components that have special safety characteristics. Only the exact manufacturer's specified parts should be used as replacements. Use of substitute replacement parts that do not have the same safety characteristics as recommended in factory service information may create shock, fire, excessive x-radiation or other hazards.

This schematic is for the use of qualified technicians only. This instrument contains no user-serviceable parts.

The other portions of this schematic may be found on other Profax pages.

RADIO DIAGRAM

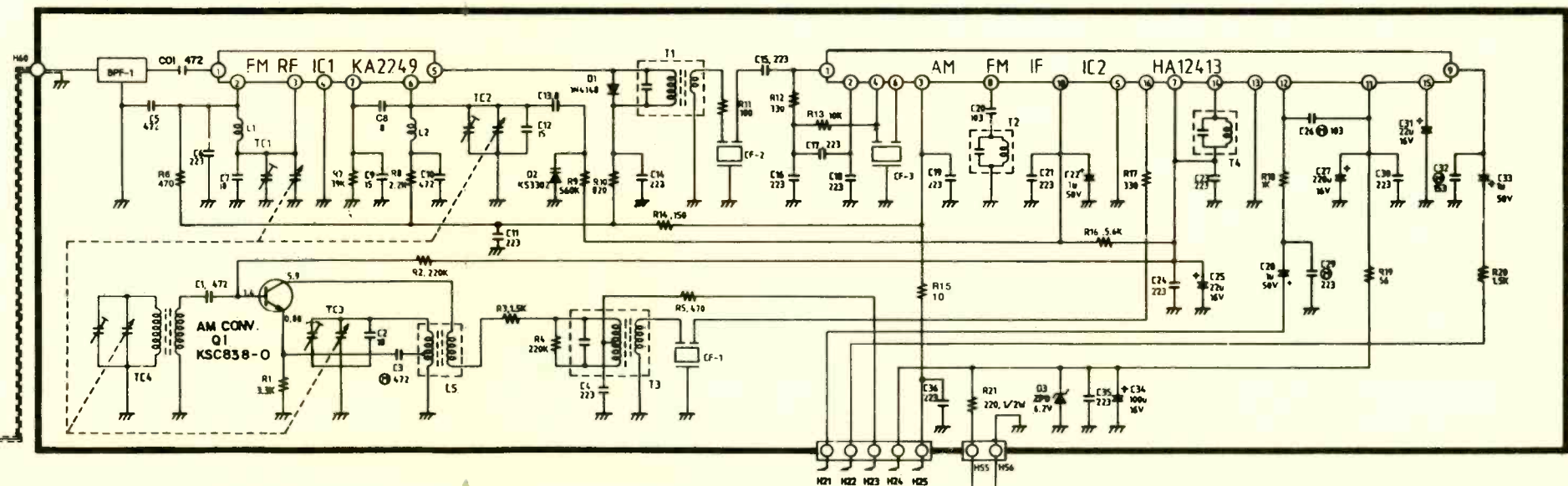

Connects to TV

1. CAPACITANCE VALUES 1.0 AND ABOVE ARE IN pF, CAPACITANCE VALUES BELOW 1.0 ARE IN μ F, EXCEPT WHERE INDICATED.
2. ALL CAPACITORS ARE RATED AT 50V EXCEPT WHERE INDICATED.
3. RESISTANCE VALUES ARE IN OHMS, K=1000, M=1,000,000.
4. WAVEFORMS MEASURED WITH STRONG SIGNAL INPUT AND CONTRAST SET TO GIVE NORMAL PICTURE.

Connects to TV

The *voltage regulator* is the circuit that keeps the output voltage of a dc power supply steady under certain varying conditions. Voltage regulators are required because some electronic circuits won't operate at all, or will operate erratically, if the applied dc voltage is not well regulated.

There are at least two sources of variation in the dc power supply voltage. Perhaps the most obvious is the normal variation present in the ac line voltage. We normally specify the line voltage (in the USA) as 110Vac or 115Vac. In reality, however, the line voltage is rarely either of these figures and may vary markedly over the course of a normal day. The usual range is 105Vac to 125Vac, with some brownout conditions permitting as low as 95Vac (fortunately, a rarity).

The other source of output voltage variation is due to changing load current. An ideal dc power supply has an internal resistance of 0Ω (it is a perfect voltage source), but this ideal is never realized in practice: All dc power supplies have internal resistance. Theoretically, we could compute this internal resistance by measuring the open-terminal (i.e. no load current) output voltage, and the short circuit load current. Don't actually try to make this measurement, however, because the power supply may destroy itself when shorted out. The internal resistance is merely V_o/I_{short} .

We can illustrate the effect of internal resistance on output voltage using a circuit such as Figure 1. Voltage source V_i , in series with resistance R_s , the internal resistance, can be used to represent a practical supply. When the load R_L is disconnected, a voltmeter connected across the terminals will read a certain value which we will call V . If switch S_1 is closed, however, the power supply will deliver a current into load R_L . Because current is now flowing, there will be a voltage drop across R_s equal to the Ohm's law value IR_s . This voltage must be subtracted from V_i to find the voltage available for R_L . In other words, V_o , the output voltage when S_1 is closed, will be $V_i - (IR_s)$.

We express the voltage regulation properties of the dc power supply in the form of a *percentage*

ABCs of voltage regulator ICs

By Joseph J. Carr, CET

of regulation, which is computed using a scenario as in Figure 1 from the equation:

$$REG(\%) = (V - V_o)/V$$

Where: V is the open-terminal voltage, and V_o is the output voltage under load.

Zener diode voltage regulators

The zener diode is the simplest form of voltage regulator device available. Figure 2A shows the normal circuit symbol for the zener diode, while Fig. 2B shows the standard zener I-vs-V curve for such a device. Note in Figure 2B

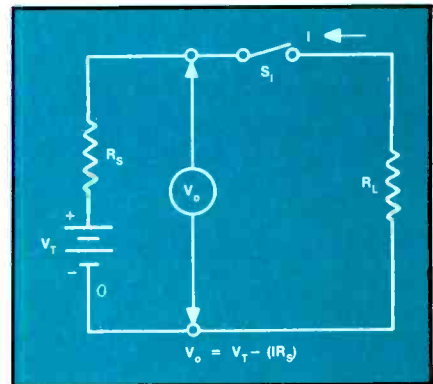

Figure 1. Internal source resistance causes variation of the output voltage of a power supply.

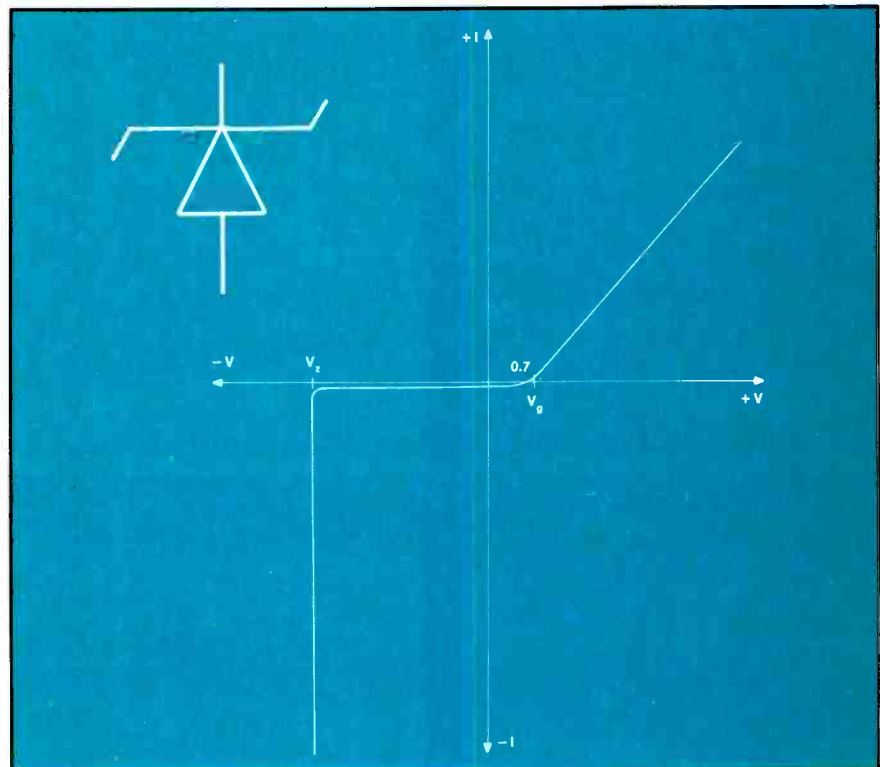

Figure 2. The zener diode (A) has a characteristic curve (B) with a steady voltage over a wide range of currents in the third quadrant.

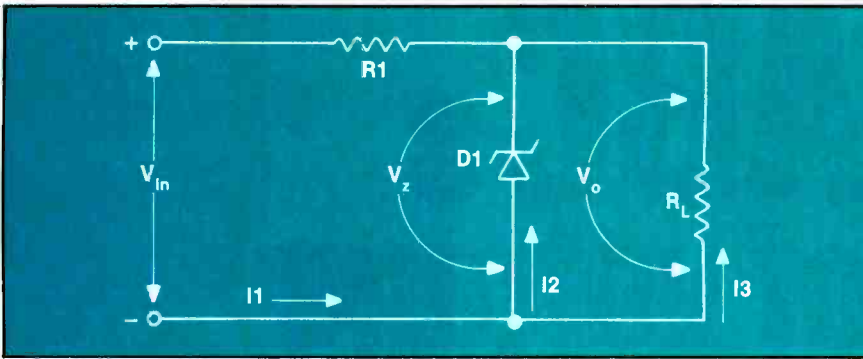

Figure 3. A typical zener diode regulator circuit.

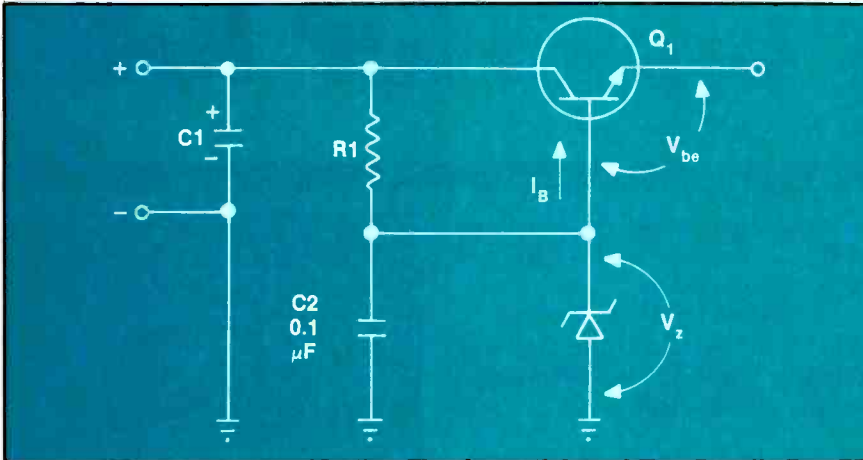

Figure 4. This series-pass transistor circuit overcomes the current limitations of the zener diode regulator.

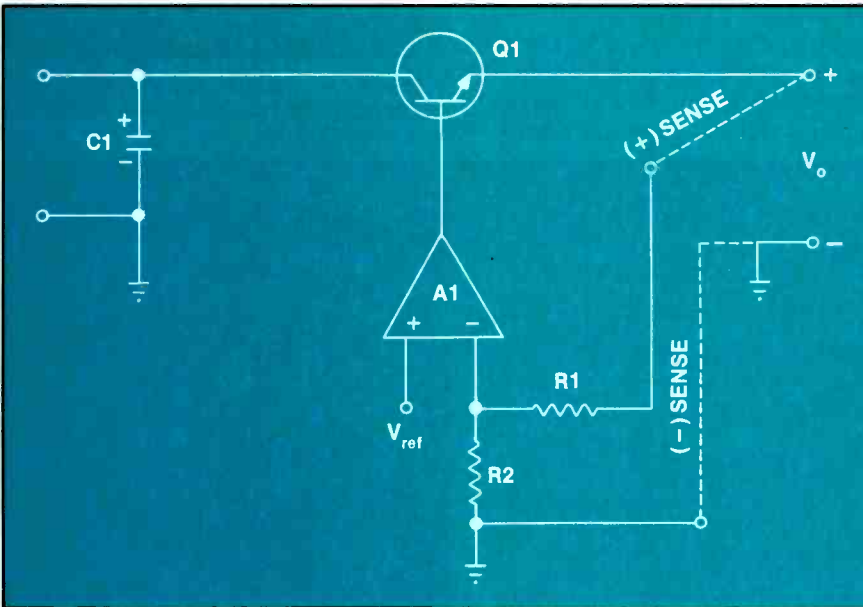

Figure 5. This circuit with its sense lines serves out IR drop in the power-supply lines.

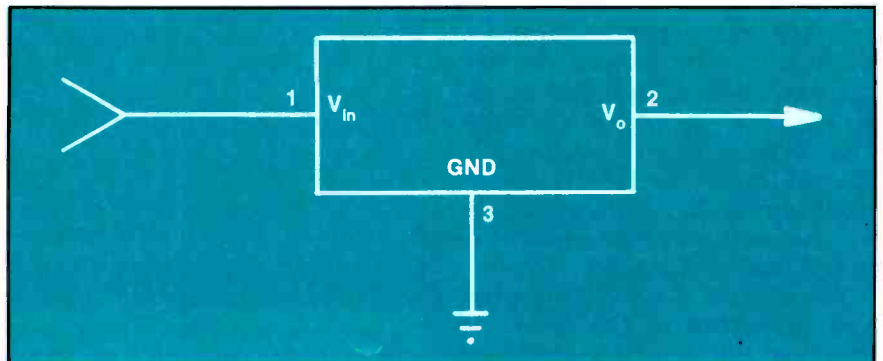

Figure 6. Voltage regulators are available in three-terminal IC packages, such as this one.

that positive applied voltages cause the diode to operate just like any other PN junction diode. The current is limited to a small reverse leakage current from zero to the junction potential point (approximately 0.6V to 0.7V for silicon rectifiers), above which the forward current increases rapidly in an Ohm's law manner.

The current is limited to leakage values in the reverse bias region, i.e. the region where the diode anode is negative with respect to its cathode. That is, until the reverse bias reaches a critical avalanche point, or *zener voltage* V_z . At that point, the reverse current suddenly increases very sharply. Although there is some variation in the zener potential, it is for many practical purposes stable despite variations in $-V$. Thus, we can use the zener diode in this mode for voltage regulation.

A typical zener diode voltage regulator circuit is shown in Figure 3. Voltage V_{in} is the voltage across a filter capacitor in a dc power supply; resistor R_L represents the load; resistor R_1 is a series resistor used to limit the current flowing in an avalanche diode; and D_1 is the zener diode. Note that output voltage V_o is the same as zener voltage V_z . We know from Kirchoff's Current Law (KCL) that $I_1 = I_2 + I_3$, where I_3 is the load current drawn from the power supply and I_2 is the zener current.

Limitations—The zener diode is not the ideal voltage regulator as some believe. It is limited in practical power supplies to low and moderate level operating currents. For higher current levels, most designers use one of the other regulator circuits described in this article. These use the zener diode as a reference voltage source for a higher current pass element. When precise voltages, or superior

thermal stability, are needed, then use band gap zener diodes.

Series-pass voltage regulators

The current limitation of zener diodes can be overcome by using a series-pass transistor, such as Q1 in Figure 4. The high current is handled by the transistor, while the zener diode is used to set the potential at the base of the transistor. The nominal output voltage will be $V_z - V_{be}$. The maximum output current is approximately the product of base current I_b and the beta of transistor Q1.

Another series-pass circuit is the feedback regulator shown in Figure 5. In this circuit, a sample of the output voltage and a reference potential are applied to the differential inputs of a feedback amplifier (A1). When the difference between V_A and V_{ref} is non-zero, the amplifier drives the base of transistor Q1 harder, thereby increasing the output voltage. The actual voltage will be stable at a point determined by V_{ref} .

The circuit in Figure 5 shows a feature that is highly useful in high current power supplies, especially where the supply must be operated more than a few inches from the load. The voltage divider R1/R2 takes the sample of output voltage V_o that drives A1. The lines from the positive output and negative output to the voltage divider are separate from the main current-carrying lines. This allows us to place these *sense* lines at the points in the actual circuit where the value of V_o must be maintained at a precise value. In a microcomputer using TTL devices, for example, we care little whether the voltage is +5V at the output of the dc power supply, but care a lot that the voltage at the microcomputer printed circuit board is +5Vdc. If we connect (+)SENSE to the +5Vdc bus, and (-)SENSE to the ground bus, then the feedback power supply will keep the voltage at the rated value at the PCB, not at the power supply! This method *servos out* IR drop in the power supply lines.

Three-terminal IC voltage regulators

Voltage regulators for low current levels (up to 5A) are reasonably simple to build now that simple 3-terminal IC

Exclusive, triple patented dynamic cap and coil analyzing . . . guaranteed to pinpoint your problem every time or your money back



with the all new LC75 "Z METER 2"
Capacitor Inductor Analyzer
Patented \$995

The "Z METER" is the only LC tester that enables you to test all capacitors and coils dynamically — plus, it's now faster, more accurate, and checks Equivalent Series Resistance (ESR) plus small wire high resistance coils.

Eliminate expensive part substitution and time-consuming shotgunning with patented tests that give you results you can trust every time. Test capacitor value, leakage, dielectric absorption, and ESR dynamically; with up to 600 volts applied for guaranteed 100% reliable results — it's exclusive — it's triple patented.

Save time and money with the only 100% reliable, in- or out-of-circuit inductor tester available. Dynamically test inductors for value, shorts, and opens, automatically under "dynamic" circuit conditions.

Reduce costly parts inventory with patented tests you can trust. No more need to stock a large inventory of caps, coils, flybacks, and IHVTs. The "Z METER" eliminates time-consuming and expensive parts substituting with 100% reliable LC analyzing.

Turn chaos into cash by quickly locating transmission line distance to opens and shorts to within feet, in any transmission line.

Test troublesome SCRs & TRIACs easily and automatically without investing in an expensive second tester. The patented "Z METER 2" even tests SCRs, TRIACs, and High-Voltage Diodes dynamically with up to 600 volts applied by adding the new SCR250 SCR and TRIAC Test Accessory for only \$148 or FREE OF CHARGE on Kick Off promotion.

To try the world's only Dynamic LC Tester for yourself, CALL TODAY, WATS FREE, 1-800-843-3338, for a FREE 15 day Self Demo.



Call Today Wats Free 1-800-843-3338

SENCORE

3200 Sencore Drive

Sioux Falls, SD 57107

605-339-0100 In SD Only

*innovatively designed
with your time in mind.*

Circle (12) on Reply Card

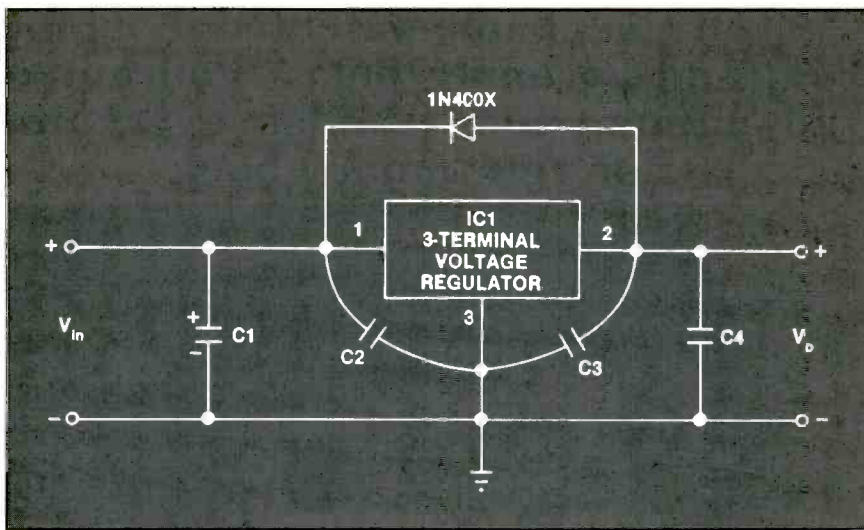

Figure 7. An IC 3-terminal voltage regulator is connected into the circuit like this.

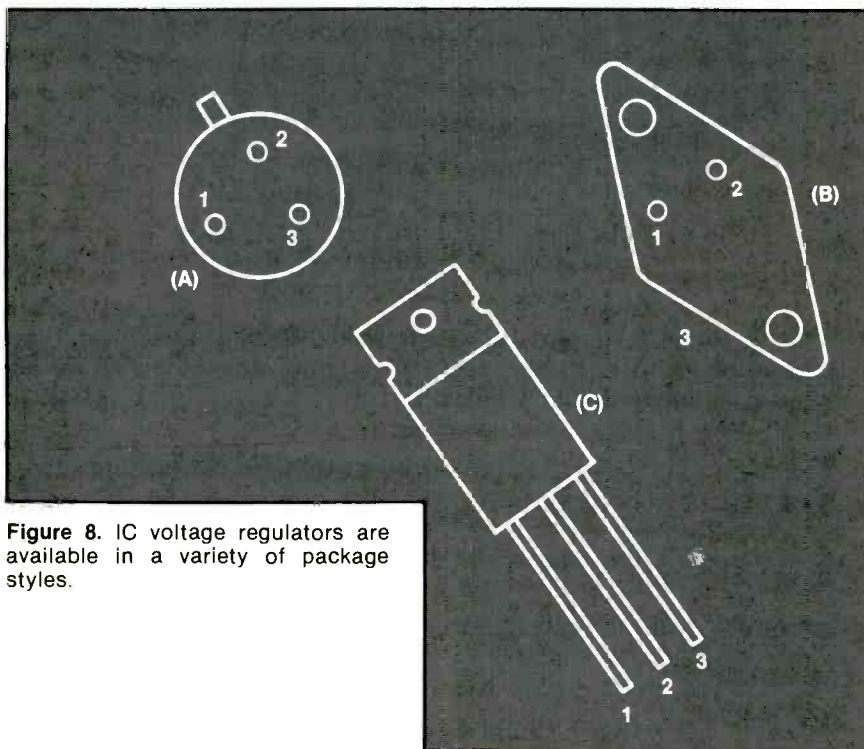

Figure 8. IC voltage regulators are available in a variety of package styles.

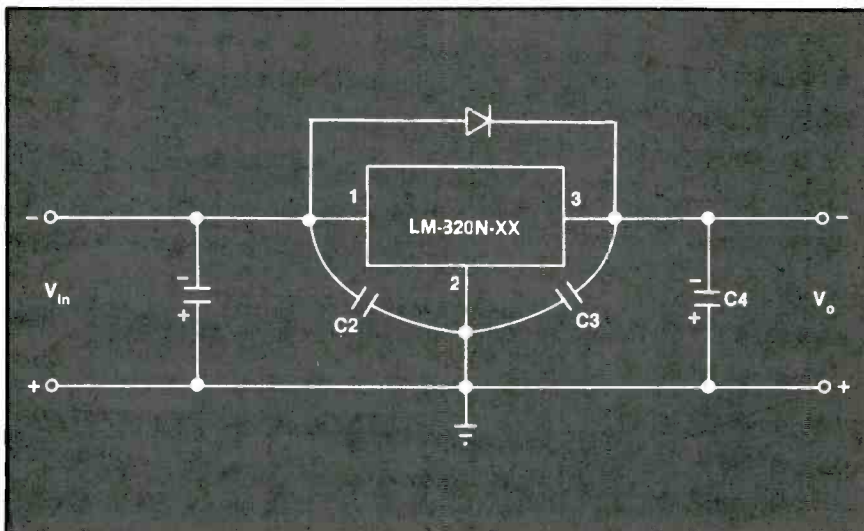

Figure 9. This is a negative version of a 3-terminal IC regulator package.

regulators (Figure 6) are available. The circuit used with positive 3-terminal regulators is shown in Figure 7, while typical package styles are shown in Figure 8. Capacitor C1 is the normal filter capacitor, and should have a value of at least $1,000\mu\text{F}$ per ampere of load current (some authorities insist on $2,000\mu\text{F}/\text{ampere}$). Capacitor C4 is used to improve the transient response to sudden increases in current demand (something that happens in digital circuits). Capacitor C4 should have a value of approximately $100\mu\text{F}/\text{ampere}$ load current. Capacitors C2 and C3 are used to improve the immunity of the regulator to transient noise impulses. These capacitors are usually $0.1\mu\text{F}$ to $1\mu\text{F}$, and are to be mounted as close as possible to the body of the voltage regulator IC1.

In cases where there are frequent failures of 3-terminal voltage regulators you might consider three possible causes: a) too-high differential input-output voltage, b) high voltage input transients and c) circuit charge dumping back into the regulator circuit. Let's consider the last of these first.

Diode D1 is not shown in a lot of circuits, but is highly recommended for applications where C4 is used, or there are other high circuit capacitances. If the diode is not present, then charge in C4 would be dumped back into the regulator when the circuit is turned off; that reverse current has been implicated in poor regulator reliability. The diode should be a 1A type at power supply currents up to 3A, and larger for higher current levels. For most 1A or less supplies, a 1N4002, 1N4003, 1N4004 or 1N4007 is sufficient (these diodes easily are found on the mailorder and TV-servicer markets). Adding the diode won't hurt the circuit, and may keep *dreadful dogs* from coming back.

Several 3-terminal IC voltage regulator packages are shown in Figure 8. The H package (Figure 8A) is used at currents up to 100mA, the K package (Figure 8B) at currents up to 1A (3A to 10A in some special cases) and the T package (Figure 8C) at currents up to 750mA. These ratings are based in part on the internal power dissipation, which leads us to another

failure mechanism. When the differential input-output voltage ($V_o - V_{in}$) is very high, heat generation also is large. In these cases, poor reliability is often traced to insufficient heat sinking. Adding (or increasing the size of) a heatsink could keep the set going long past the warranty date.

There are two general families of IC regulator. Some are designated 78xx, in which the xx is replaced with the fixed output voltage rating. Thus, a 7805 is a 5V regulator, while a 7812 is a 12V regulator. The LM-340y-xx series also is used. The y is the package style (H, K or T) while the xx is the voltage. Thus, an LM-340K-05 is a 1A, 5V regulator in a similar-to-TO3 type-K package; an LM-340T-12 is a 12V, 750mA regulator in a plastic TO-220 power transistor package.

Negative versions of these regulators are available under the 79xx and LM-320y-xx designations. Figure 9 shows the typical circuit. Note that the diode is reversed, as are the polarized filter capacitors (C1 and C4). Note also that the pin-outs on the voltage regulator device are different from those of the positive regulator. There are zillions of blown negative regulators in the trashcans of people who failed to remember this little difference when wiring a negative regulator!

The minimum input voltage to the 3-terminal IC voltage regulator is 2.5V higher than the rated output voltage. Thus, for a +5V regulator, the minimum input voltage is 7.5Vdc. The power dissipation is proportional to the voltage difference between this input potential and the output potential. For a 1A regulator, therefore, the dissipation will be 2.5W if the minimum voltage is used, and considerably higher if a higher voltage is used. It is recommended that as close as possible to the minimum be used. For +5V supplies used in digital equipment, a 6.3Vac filament transformer is sufficient. When fullwave rectified and filtered with 1,000 μ F/ampere or more, the output voltage will be approximately +8Vdc.

Figure 10 shows a dual-polarity dc power supply such as might be used in operational-amplifier-based equipment, some microcomputers and other applications. The

Analyze defective waveforms faster, more accurately, and more confidently — every time or your money back



with the SC61 Waveform Analyzer
Patented \$2,995

If you value your precious time, you will really want to check out what the exclusively patented SC61 Waveform Analyzer can do for you. 10 times faster, 10 times more accurate, with zero chance of error.

End frustrating fiddling with confusing controls. Exclusive ultra solid ECL balanced noise cancelling sync amplifiers, simplified controls, and bright blue dual trace CRT help you measure signals to 100 MHz easier than ever.

Accurately and confidently measure waveforms from a tiny 5 mV all the way to a whopping 3,000 V without hesitation with patented 3,000 VPP input protection — eliminates expensive "front end" repairs and costly equipment downtime.

Make only one circuit connection and push one button for each circuit parameter test: You can instantly read out DC volts, peak-to-peak volts and frequency 100% automatically with digital speed and accuracy. It's a real troubleshooting confidence builder.

Confidently analyze complex waveforms fast and easily. Exclusive Delta measurements let you intensify any waveform portion. Analyze glitches, interference signals, rise or fall times or voltage equivalents between levels; direct in frequency or microseconds.

Speed your digital logic circuit testing. Analyzing troublesome divide and multiply stages is quicker and error free — no time-consuming graticule counting or calculations. Simply connect one test lead to any test point, push a button, for test of your choice, for ERROR FREE results.

To see what the SC61 can do for your troubleshooting personal productivity and analyzing confidence, CALL TODAY, WATS FREE, 1-800-843-3338, for a FREE 15 day Self Demo.



Call Today Wats Free 1-800-843-3338

SENCORE

3200 Sencore Drive
Sioux Falls, SD 57107
605-339-0100 In SD Only

*innovatively designed
with your time in mind.*

Circle (13) on Reply Card

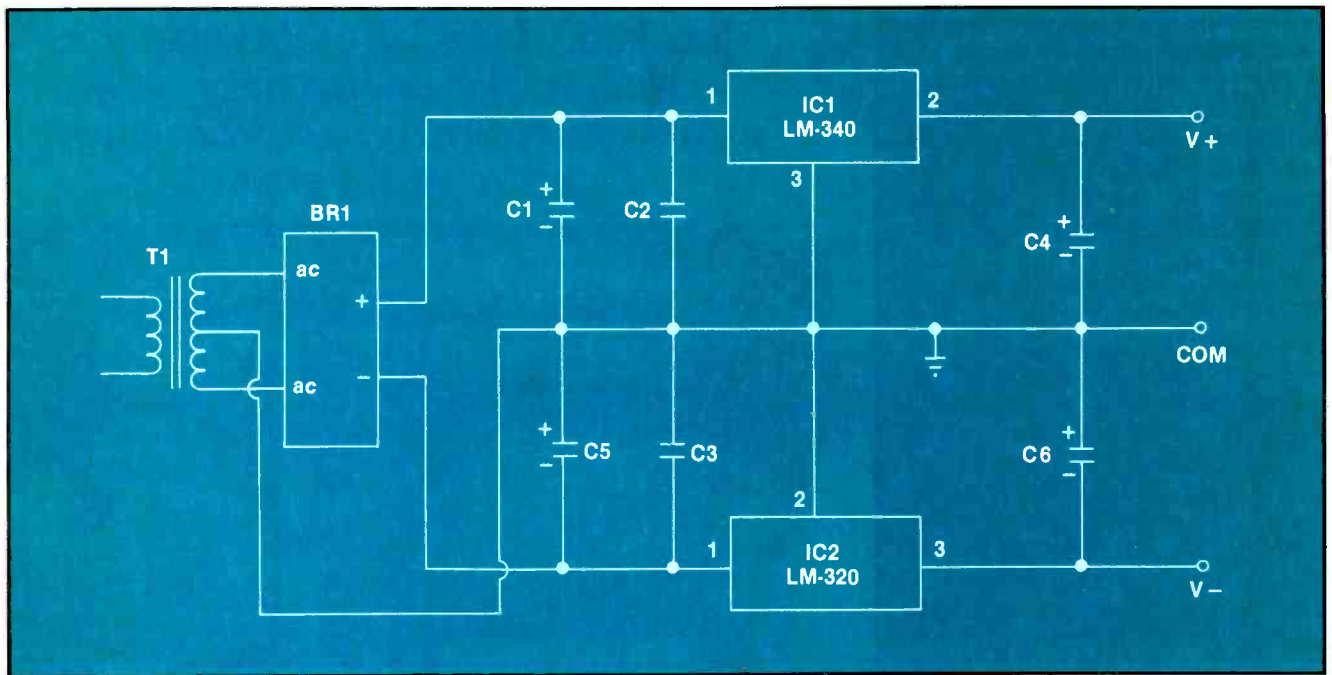

Figure 10. A dual-polarity dc power supply using one positive and one negative IC voltage regulator.

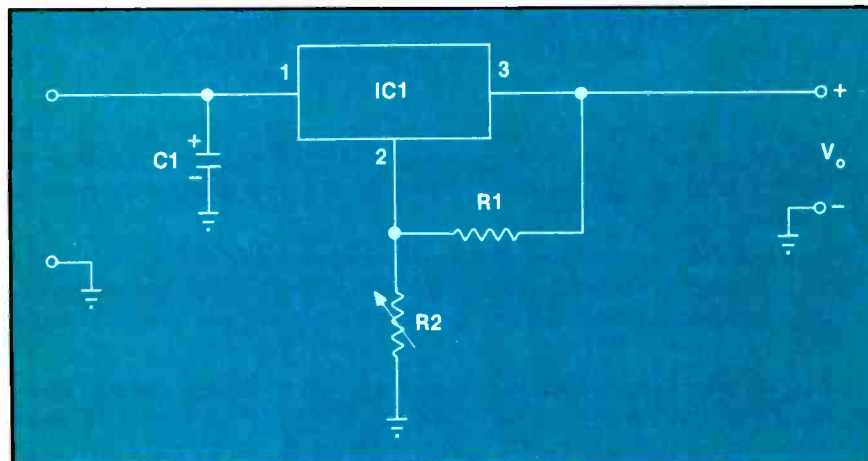

Figure 11. This is typical of a circuit using an LM-317 or 338 voltage regulator.

voltage regulator portion of the circuit is merely a combination of Figures 7 and 8. The transformer/rectifier section bears some explanation, however. The rectifier is a 1A bridge stack, but is not used fullwave. The center-tap of transformer T1 establishes a zero-reference, so the bridge consists of a pair of half-wave bridges connected to the same ac source. Thus, the (-) terminal of the bridge stack drives the negative voltage regulator, and the (+) terminal drives the positive voltage regulator.

Because Figure 10 is half-wave rectified, the 1,000 μ F/ampere rule is scrapped, and a 2,000 μ F/ampere preferred. Because this is a 1A supply, therefore, C1 and C5 are rated at 2,000 μ F. Also because of

the halfwave rectification, the transformer rating must be greater than would be required for normal fullwave service. Because of the *half-current* rule, and the fact that the halfwave rectifier is less efficient than the fullwave, it is recommended that the secondary of T1 deliver at least 2.8 times the amount of current available from both V- and V+.

Adjustable IC voltage regulators

The LM-317 and LM-338 voltage regulators are capable of delivering up to 1.5A and 5A, respectively, at voltages up to +32Vdc. Figure 11 shows a typical circuit for these regulators. In some cases, fixed resistors provide a fixed output voltage, while in others a potentiometer is used to

provide adjustable voltage. The input voltage must be 3V higher than the maximum output voltage. The output voltage is set by the ratio of two resistors, R1 and R2, according to the equation:

$$V_o = (1.25V) \left(\frac{R2}{R1} + 1 \right)$$

An example from the National Semiconductor, Incorporated *Linear Databook* shows 120 Ω for R1, and a 5k Ω potentiometer for R2. This combination produces a variable output voltage of 1.2Vdc to 25Vdc, when V_{in} is >28Vdc. Diode D1 can be any of the series 1N4002 through 1N4007 for LM-317 supplies, and any 3A type for LM-338 supplies.

Troubleshooting

In general, troubleshooting the IC 3-terminal regulator is simple: measure the pin voltages. A bad regulator generally produces a voltage that is either too high or too low. If the other pin voltages are near normal, then it's a reasonably sure bet that the IC regulator is bad. Although faults such as low input voltage, an open ground line on the printed circuit board, or a short in the output circuit can counterfeit a *bad regulator* problem, these are easily checked out.

Reliability problems

Earlier I mentioned three main causes of reliability problems. Two of these have been discussed. The last, destruction of the device by high voltage transients, can be

found most often in equipment operated from poor ac power lines, or in close proximity to machinery that places transients on the line. A lot of industrial electronics equipments fail for this reason. The voltage regulator may be protected by A.) ensuring that 0.1 μ F to 1.0 μ F capacitors shunt the input and output terminals of the IC voltage regulator, and B.) a metal oxide varistor (MOV) device shunts the ac power lines that feed the power supply.

Parts substitution

There are remarkably few 3-terminal fixed and adjustable voltage regulators on the market. I recommend technicians keep at least the *National* data book on hand for purposes of locating and identifying suitable substitutes when parts for equipment being serviced are either too hard to obtain or are too costly. Any number of sources, both industrial and mailorder, offer lower prices on generic 3-terminal regulators than some of the regular sources that a servicing technician might rely on.

Renovating older equipment

During the time when I serviced biomedical electronics equipment in a large eastern hospital, there were many times when older equipment arrived in our shop with a burned up dc voltage regulator circuit. In most of these equipments, the voltage regulator was on a separate plug-in printed circuit board. Those circuits were made from discrete transistors, and output ± 12 Vdc at less than 1A. We often made new circuit boards (the older ones being unavailable) from Vector perf-board (the kind with a cardedge connector on one end). The circuitry was merely K-packaged LM-series 3-terminal IC regulators: LM-340K-12 for +12Vdc and LM-320K-12 for -12Vdc.

Conclusion

All sorts of electronic equipment, consumer, industrial, commercial and military are being designed with 3-terminal IC voltage regulators. There are only a few generic types on the market, and you can substitute these generics for the *part numbered* versions of the same devices in equipment that you service. **ES&T**

Now test and restore every CRT on the market . . . without ever buying another adaptor socket or coming up embarrassingly short in front of your customer . . . or your money back



**with the new improved CR70 "BEAM BUILDER"™
Universal CRT Tester and Restorer
Patented \$995**

Have you ever?

Thrown away a good TV CRT, data display CRT, or scope CRT that could have been used for another two or three years because you had no way to test or restore it?

Lost valuable customers because you advised them that they needed a new CRT when another technician came along and restored the CRT for them?

Lost the profitable extra \$35 or more that you could have gotten for restoring a CRT while on the job and locked in the profitable CRT sale later?

Avoided handling profitable trade-ins or rentals because you were afraid you'd have to replace the picture tube when you could have restored it?

Had a real need to test a CRT on the job, but didn't have the right adaptor socket or setup information in your setup book?

If any of these things have happened to you, CALL TODAY, WATS FREE, 1-800-843-3338, for a FREE 15 day Self Demo.

"BEAM BUILDER" is a trademark of Sencore, Inc.



Call Today Wats Free 1-800-843-3338

SENCORE

**3200 Sencore Drive
Sioux Falls, SD 57107
605-339-0100 In SD Only**

*innovatively designed
with your time in mind.*

Circle (14) on Reply Card

Scoping TV power-supply sources

By Bud Izen, CET/CSM

Technicians usually get hung up on "dogs" for one of three reasons: making an assumption they were not entitled to make, lack of understanding of a basic concept or failure to perform an analysis in a methodical way (sometimes a combination of those factors). It is rare, indeed, that the reason a technician finds a certain problem difficult to solve is because of a lack of advanced knowledge of circuit theory. No matter how many new circuits or combinations of circuits the engineers may dream up, they still are composed of fundamental building blocks that rely on basic theory to operate. If you have a solid understanding of fundamental knowledge, and review it a lot, you will encounter far fewer dogs than the average technician.

This is important to remember: Regardless of the types of electronic devices you end up working on in the future, the functional block most prone to failure *is and will continue to be* the power supply. This is because it handles all the power used by the device. Notice I said *handles* and not *consumes*.

The first steps of methodical troubleshooting allow you to isolate the source of the symptom to a defective block. Once you have reached that point, the next step is to make sure that the power supply *reaching the block* is correct. *Correct* means that the value of the voltage measures very close to the schematic value (certainly well

within 10% for most solid-state sets, and usually within 5% for sets having electronically regulated supplies) and has an acceptable level of ripple. The value of the voltage is usually checked with a voltmeter. Digital meters

are a necessity these days, because most solid-state sets using integrated circuits require the voltage to be correct to at least one or two decimal places.

The oscilloscope, however, is a more convenient tool for quick and

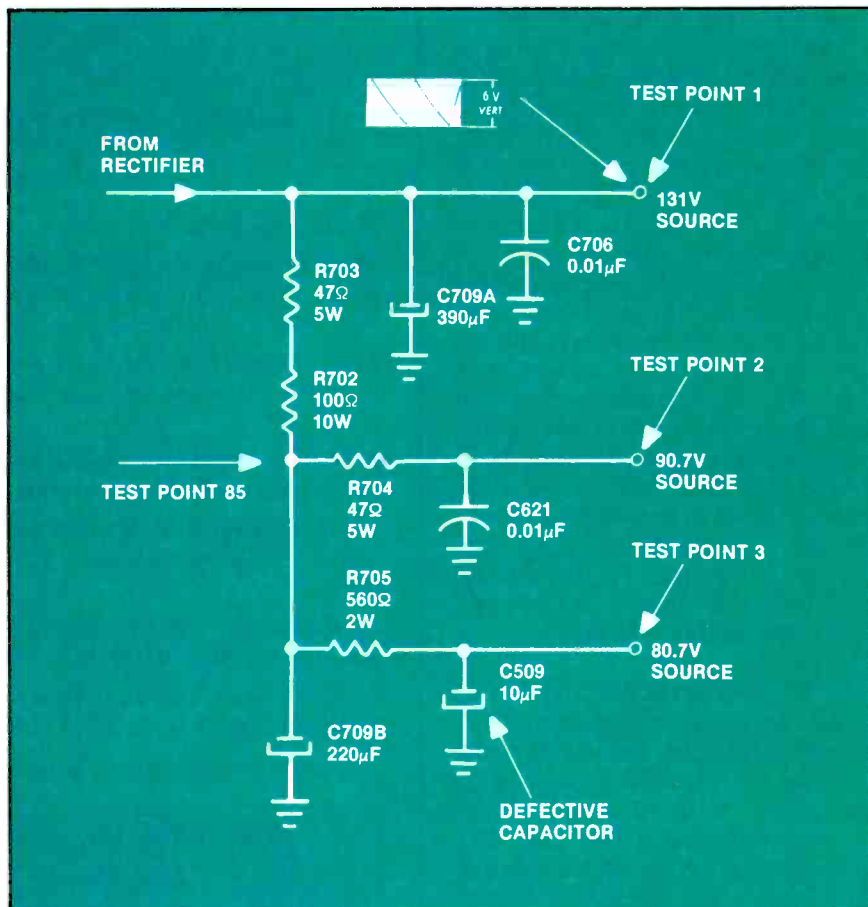

Figure 1. A defective capacitor in this power supply circuit caused a reduction in the voltage supply to the vertical circuit in this Sanyo TV set. One of the symptoms was the presence of 59.94Hz vertical pulses across capacitor C509.

Walk "tough dog" troubles out of any TV & VCR in half the time . . . or your money back

accurate analysis. Using the scope, you can examine the dc voltage level and ripple voltage at the same time. From time to time, someone will ask me how to tell how much ripple should be present on a power supply line when the schematic gives no indication. A good example of this is found if you look at Figure 1. This comes from Sams Photofact 1971-2. Although this is a B&W set, which my class received as a donation in defective condition, its power supply and failure symptom are common enough to use as an example of the principle I am talking about.

Notice that the ripple waveform at point 1 is the only one given.

Here comes the part where you have to start using your brains and your knowledge of basic electronics. Remember, troubleshooting analysis should be composed mostly of thinking rather than just taking a bunch of measurements. So let's analyze the circuit of Figure 1. First of all, let's start with what we are given (always the best place to start). This may seem simplistic, but I always am surprised at how many technicians want to start working based on what they *assume* to be true rather than what they *know* to be true.

At point 1, you can see that we expect a dc voltage of 131V and a ripple voltage of 6V. Both of those voltages should be dropped somewhat across R702 and R703 when current is drawn; Ohm's law indicates as much. This is easily verified from the schematic that shows 90.7V at point 2 and 80.7V at point 3. Because the schematic offers no other ripple waveform, it might be correct to assume that elsewhere in the power supply the ripple should be too small to consider. Rather than just accept that, perhaps we should question if that assumption is true, and if it is, why it is. The dc voltage dropped (for example) from 131V to 80.7V between points 1 and 3. That is a reduction of 50.3V amounting to about 38%. Because the ripple must pass through the same resistors, it should also be reduced by *at least* this same amount, due to Ohm's law. I say at least because

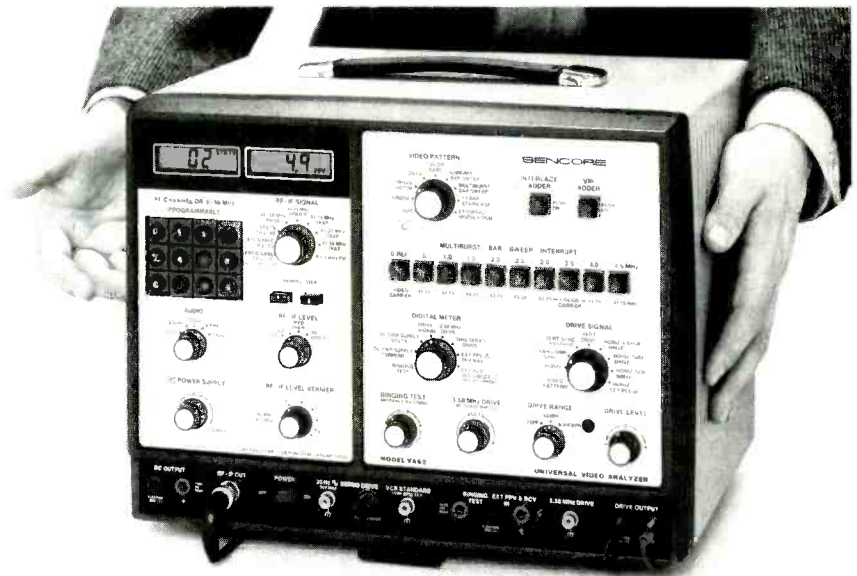

with the exclusive, patented,
VA62 Universal Video Analyzer . . . \$3,295

Would you like to?

Reduce analyzing time: Isolate any problem to one stage in any TV or VCR in minutes, without breaking a circuit connection, using the tried and proven signal substitution method of troubleshooting?

Cut costly callbacks and increase customer referrals by completely performance testing TVs & VCRs before they leave your shop? Own the only analyzer that equips you to check all standard and cable channels with digital accuracy? Check complete, RF, IF, video and chroma response of any chassis in minutes without taking the back off the receiver or removing chassis plus set traps dynamically right on CRT too? Simplify alignment with exclusive multiburst pattern?

Reduce costly inventory from stocking yokes, flybacks, and other coils and transformers, for substitution only, with the patented Ringing Test. Run dynamic proof positive test on any yoke, flyback, and integrated high voltage transformer . . . in- or out-of-circuit?

Protect your future by servicing VCRs for your customers before they go to your competition? Walk out "tough dog" troubles in any VCR chrominance or luminance circuit — stage-by-stage — to isolate problems in minutes? Have proof positive test of the video record/play heads before you replace the entire mechanism?

Increase your business by meeting all TV and VCR manufacturers' requirements for profitable warranty service work with this one universally recommended analyzer?

To prove it to yourself, CALL TODAY, WATS FREE, 1-800-843-3338, for a FREE Self Demo . . . or learn how the VA62 works first by calling for your free simplified operation and application instruction guide, worth \$10.00.



Call Today Wats Free 1-800-843-3338

SENCORE

3200 Sencore Drive

Sioux Falls, SD 57107

605-339-0100 In SD Only

*innovatively designed
with your time in mind.*

Circle (15) on Reply Card

there are other components that affect the ripple besides just the resistors. In any case, the maximum ripple should be no greater than 38% of 6V or 2.28Vp-p.

C709B is a 200 μ F capacitor that has a reactance of about 12 Ω at the line frequency according to the formula:

$$X_c = 1/(2\pi fC) = 1/(2 \times 3.14 \times 60 \times 0.000220).$$

We all know that reactance and resistance cannot be added directly. However, because the values are so small, only a slight error will be introduced if we do so. For the sake of rapid analysis, therefore, let's just do a voltage divider formula treating X_c like R . This means that at point 85, as far as the ripple goes, there should be no more than 12/162 (X_c divided by the approximate total of X_c plus the values of R702 and R703) of the ripple present at point 1. This would be about 0.44Vp-p maximum. Not very much indeed. This is a lot larger reduction than our previous estimate of 38%. It is more like a reduction of 93%!

Let's do the same to calculate the maximum ripple at point 3. Using the same formula, the reactance of C509 should be about 265 Ω . This creates an approximate voltage divider between R705 and C509 of 265/825 so that no more than 0.14Vp-p of the original ripple should remain at point 3. See how that basic theory helps.

If you didn't go through that analysis, you might have the same thing happen to you that happened to one of the technicians I supervise. When the set came in, it was assigned to one of the students who turned it *on*, examined the symptoms and turned the controls. These are the first steps that any good technician would take as part of a preliminary diagnosis. He then noted that although the picture was stable, the vertical hold control was at one end of its range.

All of us make assumptions when we troubleshoot. How good a technician we are is often determined by how few assumptions we make. It would be reasonable to assume that the problem in this case was a defective control, a resistor or capacitor in the

frequency-setting time constant circuit, a leaky transistor, a defective capacitor in the control circuit, or a cold solder joint. After all, these are all viable possibilities.

As stated earlier, you should never assume that the power supply cannot be related to the heart of the problem. It is good practice to check the power supply first, once the source of the symptom has been isolated, regardless of the symptom, but check the power supply voltage at the circuit under suspicion, not at the power supply itself. Why? Remember cold solder joints, bad connections, and secondary dropping resistors and filters, illustrated as part of the circuit but in function actually part of the power supply, certainly can cause problems.

In this case, the first thing the student did was to whip out the voltmeter only to find that the voltage was about 70V instead of 80. Because he was not yet familiar with the scope, he could go no further. So he referred it to the senior technicians.

The CET confirmed the student's diagnosis, but then started to make assumptions. Is it reasonable to assume that if the power supply to the vertical output circuit is low, that the symptom would be insufficient height? Well, the answer is maybe. As in maybe it would be unless the technician (or customer) already has turned the height control to make up for it. However, the tech made the mistake of assuming that this would be the only symptom which the reduced power supply voltage could cause. Then he made a worse assumption, based on the first. Without thinking about the fact that the set was not drawing any more current than usual, he assumed that the vertical circuits were loading down the power supply, and that this was related to the control not working correctly.

I became aware of the problem after the tech had been working on the set for the better part of an hour. He came to me with questions about the Miller capacitor and so forth. I told him that I thought the problem might be a bit more basic, and it was.

I asked him if he had measured the power supply. He said yes, and that it was 10V low. I asked him if the power supply was "clean" as in pure dc. He said that he did not know. We then scoped the waveform that was present at point 3 and got what you see in Photo 1.

I asked him what he thought that was. He said, again making an incorrect assumption, that it was ripple. Although the scope was set to display the line frequency, that oddball waveform certainly did not look anything like what we all call ripple, which gets its name from its waveshape. The amplitude of that messy pulse was about 20V. I asked him if he thought that this was an acceptable level of ripple and he said that he did not know, that a value was not given on the schematic. I asked him where ripple came from, and he correctly indicated that it originated from pulsating dc created by the rectification of the incoming ac. I asked him to scope point 85, where he got the waveform of Photo 2. He still did not get it. Finally, I indicated that it was impossible to get something for nothing, and could he just *guess* at where the waveform of Photo 1 was coming from. He said that it was coming from the vertical output, but did not sound confident enough to argue the point.

I asked him to carefully examine

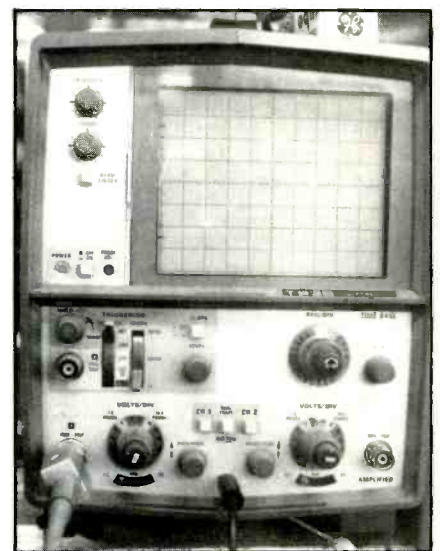

The waveform at Test Point 3 in Figure 1, which should have been almost pure dc, exhibited these 20V pulses.

the waveform and see that indeed there were pulses on it. He agreed that it did appear to come from the vertical circuit. I asked him if he thought that the capacitor (C509) could tell the difference between the 60Hz ripple and the 59.94Hz vertical output pulses, and he said no. So I asked him then, what did he think was causing the problem. The light went on, and in less than five minutes, a new C509 cured the symptom, and the control would vary the vertical frequency faster and slower than normal from the approximate center of rotation.

If you're a basic theory oriented technician, you'll rarely overlook little things like this. Always scope

that power supply first.

Here's another problem tailor-made to illustrate the exact troubleshooting methods I have been talking about. A Panasonic set using the ETA-12 chassis (Sams Photofact 1499-1) came in for a tuner-related problem. After we fixed the original complaint, we performed the standard set-up adjustments, the first of which was to check and set the B+ voltage. Refer to Figure 3. The main power supply voltage, measured at point 1, should have been 110V. We found it about 15V higher than normal. Because we always use a variable ac power supply to hold the input ac constant at the manu-

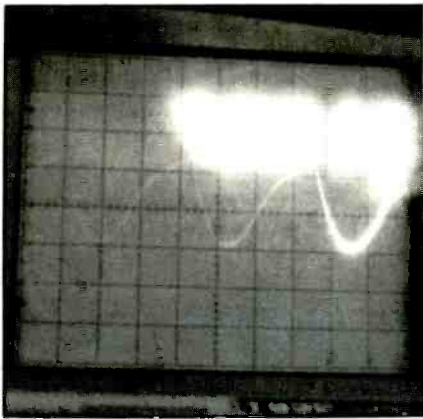

The presence of these 0.4Vp-p pulses at Test Point 85 confirmed that the pulses at Test Point 3 were not ripple, but were coming from somewhere else.

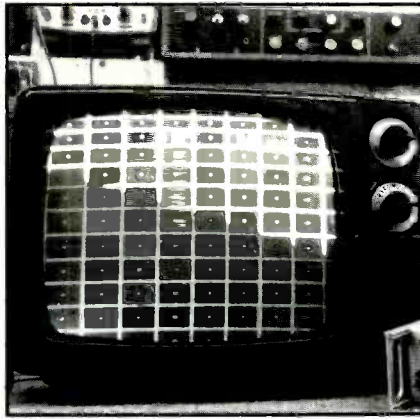

When the B+ voltage of the set with schematics shown in Figures 2 and 3 was properly adjusted and the height correct, nonlinearity was exhibited.

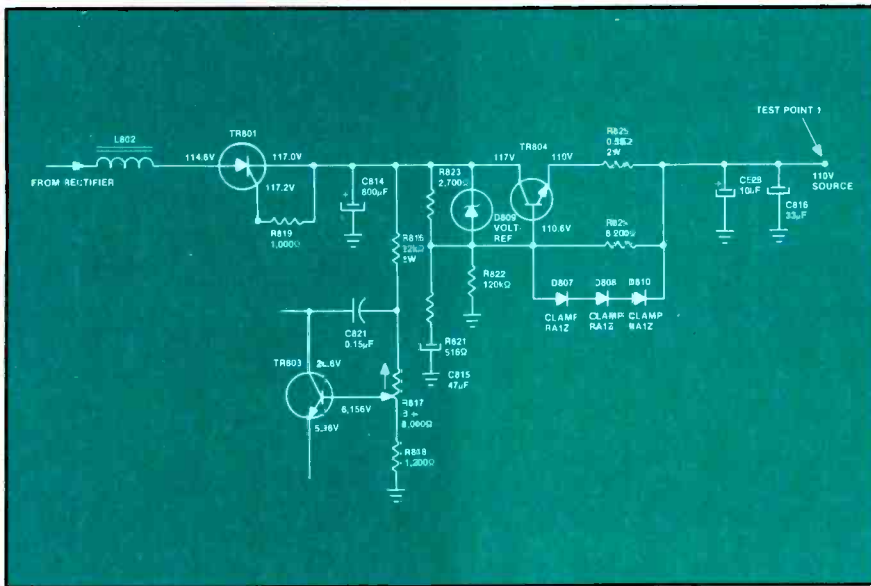

Figure 2. A check of the 110V voltage source on this Panasonic set revealed a voltage that exceeded the expected voltage by 15V. When the B+ adjustment was adjusted to return this voltage to its correct value, it was impossible to achieve both proper height and linearity.

Capacitance, logic and more. For less.

Now, a fully-loaded DMM combines a capacitance meter, logic probe, and an hFE meter, all for the price of a DMM.

TTL Logic Probe: 20 MHz

Hi/lo/off indications

Detects 25nS pulse width

Capacitance: 5 ranges (2nF to 20µF)

hFE (NPN or PNP): 1 range (1000)

DMM: DCV-5 ranges (.2V to 1kV)

ACV-5 ranges (.2V to 750V)

DCA-4 ranges (200µA to 10A)

ACA-3 ranges (20mA to 10A)

Ohms-7 ranges (200 Ohms to 2000 Megohms)

Continuity beeper

Diode check

Built-in bail

Anti-skid pads

See one now at your local Beckman Industrial distributor.

DM25L... \$89.95*

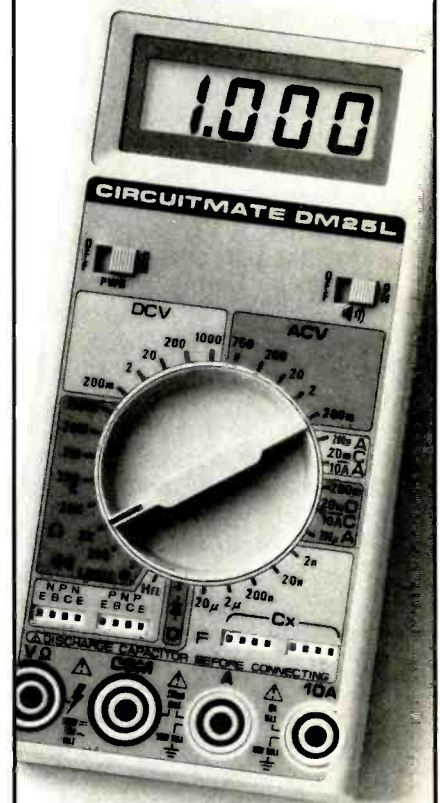

*Suggested list price (\$US) with battery, test leads and manual.

Beckman Industrial™

Beckman Industrial Corporation
A Subsidiary of Emerson Electric Company
630 Puente Street, Brea, CA 92621
(714) 671-4800

© Copyright 1985 Beckman Industrial Corporation

Circle (16) on Reply Card

facturer's recommended voltage (120Vac in this case), all we had to do was turn the B+ adjustment (R817) and the proper dc output was obtained.

Unfortunately, when the main dc voltage was adjusted back to normal and we proceeded with the set-up adjustments, it was impossible to obtain proper height and linearity. If we were willing to put up with exceedingly poor linearity then we could get enough height, but if the linearity control was adjusted for a linear vertical scan, we could not get enough height. (See Photo 3.)

I let the technicians work on this for over a week, an hour or so at a time. I figured it would be more educational for them to go through it themselves until they acknowledged defeat. (I was trying to get them to see that if they were not hot on the trail within 30 minutes, that it was likely that they would be no closer after several hours. Such turned out to be the case.)

Finally, they came to me for assistance. I made my own fatal assumption: that at sometime during the past week they had checked the power supply feeding the vertical circuits. Refer to Figure 4. It turns out that the vertical circuits are fed by both power supplies 1 and 2. They told me that both measured all right (with a meter) where they came into the vertical circuits.

We then took voltage and waveform measurements throughout the circuits and found that all was fine until we reached the input waveforms to the output devices. When adjusted for proper linearity, the waveforms had insufficient amplitude but not as much as expected from viewing the symptom.

I like asking for help with non-standard failures, so I called a local dealer friend of mine who probably sees more Japanese color sets in two weeks than we see at school all year. When I described the symptoms and what we had done, he said that he had seen nothing like this, but had we checked the power supply? I said that we had, but this started me thinking along the lines of the analysis I presented above.

Notice that there are two places

where power supply 1 feeds the vertical circuits at which its voltage is reduced by a dropping resistor, and the result is filtered by a relatively small-value electrolytic. This occurs in the collector circuits of TR453, the vertical driver, and TR454, the lower vertical output transistor. It appeared worth the time to measure and scope the dc at the collectors of both devices. The voltage at TR453 was clean and correct. However, the voltage at the collector of the output device was a lot lower than expected and had a significant pulse on it (definitely not ripple). Unlike the previous example, the pulse was not radiated back through the power supply to any other circuits, which perhaps made it harder to find.

As you can imagine, replacement of the capacitor restored the correct dc level and completely remedied the symptom. Proper height and linearity were restored. It was obvious that the technician who had previously worked on the

set had cranked up the B+ to hide a problem he could not remedy. The unfortunate part of that was that he caused a hidden safety defect, because increasing the B+ also increased the high voltage beyond the recommended level. (The set obviously had been worked on before—several components in the vertical circuits had been changed and removed from the circuit; the solder work was not factory quality. On its own, the B+ adjustment could not have drifted so far out of adjustment.

The moral of the story is that it is very important both to scope and measure the dc power supply. A secondary lesson that should be learned from this is to scope and measure any voltage that is reduced and filtered to feed any particular circuit to which the suspected cause of a symptom has been localized. Once this analysis becomes second nature to you, you will never worry about the question: Is it the power supply or is it the circuit?

ES&T

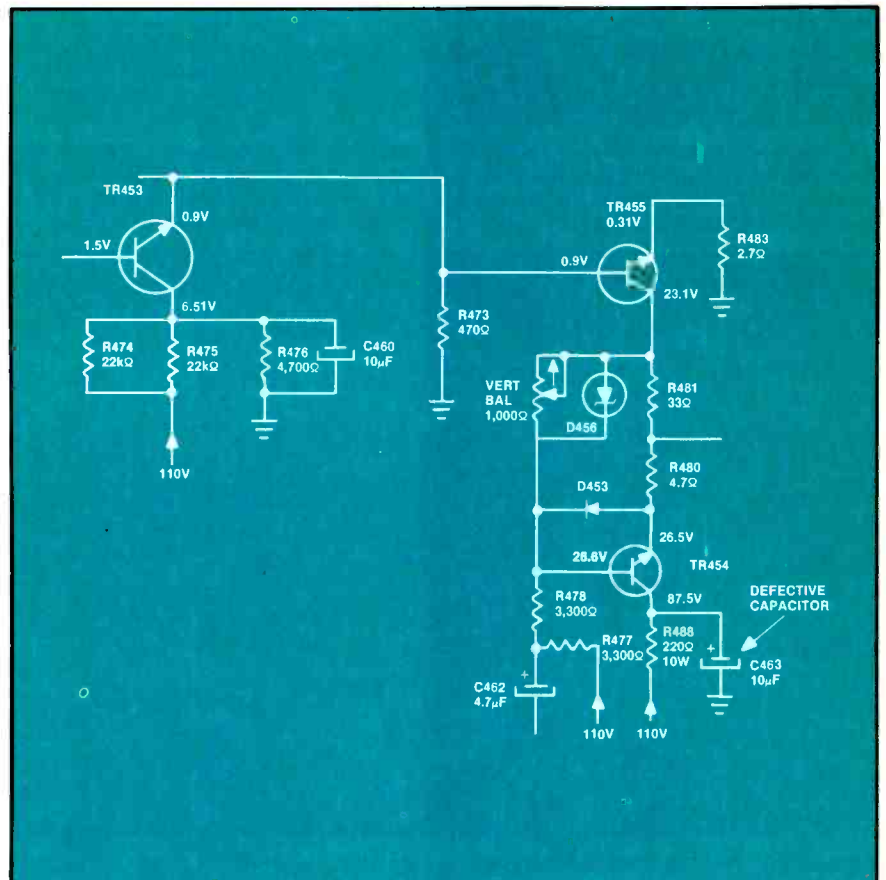

Figure 3. A defective electrolytic capacitor in the vertical circuitry was causing the problem in the Panasonic set. Replacement remedied the problem.

Books

Electronic Devices and Circuits – 3rd edition, by David Bell; Prentice-Hall, 756 pages, \$32.95, hardbound.

Although this book is targeted toward college and university classrooms, it will be useful as a reference text for practicing technicians and engineers. The operation of all important electronic devices in general use appears to be clearly explained, as well as are the electronic circuits using these devices. Many practical design and analysis examples are included, with most equations derived so that the reader easily can follow the design procedure. There are review questions and problems at the end of each chapter.

Besides being completely rewritten, this edition introduces a section devoted to employing computers in circuit design and analysis.

Published by Prentice-Hall, Inc., Englewood Cliffs, NJ 07632; 800-223-2336.

The Computer Power Buyers Guide; Wellspring Enterprises; approximately 300 pages, \$39.95, softbound.

To be available in November, the 1987 edition of this large, manual-size buyers guide that lists nearly 2,000 computer power sources and power conditioners from more than 70 manufacturers. The publication lists products in six major categories and 31 subcategories by power level (VA) and manufacturer. Categories listed include stand-by power systems and uninterruptible power supplies.

Published annually by Wellspring Enterprises, 9921 Carmel Mountain Road, Suite 188, San Diego, CA 92129; 619-484-4479.

Sams/TI Understanding Series; acquired from Texas Instruments by Howard W. Sams, a division of Macmillan, Inc.; 12 softbound books, \$14.95 each, as listed below:

- Understanding Artificial Intelligence, by Henry C. Mishkoff, 258 pages;
- Understanding Automation Systems – 2nd edition, by Farwell and Schmitt, 280 pages;

- Understanding Automotive Electronics – 2nd edition, by Ribbens and Mansour, 288 pages;
- Understanding Communications Systems – 2nd edition, by Cannon and Luecke, 288 pages;
- Understanding Computer Science – 2nd edition, by Roger S. Walker, 280 pages;
- Understanding Computer Science Applications, by Roger S. Walker, 284 pages;
- Understanding Data Communications – 2nd edition, by Fike, Friend, Bellamy and Baker, 272 pages;
- Understanding Digital Electronics – 2nd edition, by Gene W. McWhorter, 264 pages;
- Understanding Digital Troubleshooting – 2nd edition, by Don L. Cannon, 272 pages;
- Understanding Microprocessors – 2nd edition, by Cannon and Luecke, 288 pages;
- Understanding Solid-state Electronics – 4th edition, by Haford and McWhorter, 286 pages;
- Understanding Telephone Electronics – 2nd edition, by Fike and Friend, 288 pages.

Published by Howard W. Sams & Company, 4300 W. 63rd St., Indianapolis, IN 46268; 317-298-5400.



Photofact

These Photofact folders for TV receivers and other equipment have been released by Howard W. Sams & Co. since the last report in ES&T.

GENERAL ELECTRIC

Chassis 19PM-C 2444-1

PORTLAND

TCK-2003PN/03PR/61P 2439-1

PORTLAND

TCK-403P/04P/05PR 2440-1

QUASAR

Chassis GC133 2439-2

QUASAR

Chassis GC125 2440-2

QUASAR

Chassis ADC114, AEDC114, AELDC114 2442-1

RCA

Chassis CTC131A, CTC131M 2445-1

SAMPO

Chassis C6-19C 2442-2

SAMPO

Chassis C6-19A/B/C 2443-1

SANYO

Chassis A6F-51100, A6F-51500 2444-2

SHARP

19J91 2439-3

SHARP

13J350, 13J370 2441-1

ZENITH

SB1965W/65WK/71P/77S 2441-2

ZENITH

SB2523G6/23K6/27P6/31N6/41K/87P6/91P/95P3/97Y3 2443-2

MONITOR

AMDEK

Color 600/700/710 2445-2

What do you know about electronics?

By Sam Wilson

Microprocessor

The title of this article is a misnomer because in the tuning system described here, the microprocessor performs a relatively minor task. The important work is done by a phase-locked loop.

The weakest link in a broadcast system seems to be at the point where the listener selects the desired station. Many different types of tuning have been tried. None of them are totally successful.

With the analog system the listener turns a knob that moves a pointer across a numbered dial. When the desired station is reached, the listener stops tuning. Unfortunately, the dial often overshoots the mark and the result is distorted sound.

The microprocessor tuner is designed to eliminate the possibility of a mistuned station. It is a great innovation for people who really do want to listen to music.

The block diagram in Figure 1 is for a typical tuner in a superheterodyne receiver. If this is an FM tuner, it must be able to select one of 99 channels or stations between 88.1MHz and 107.9MHz. With 99 stations available, it is possible to make a detent tuner that stops at each of the 99 carrier frequencies. In that case, the detent tuner would do the same job as the microprocessor tuner does.

For this discussion, we will assume that the listener has selected a station at 99.9 MHz. As shown in Figure 1, the local oscillator must be tuned to 110.6 MHz in order to get a difference frequency, or intermediate (IF) frequency, of 10.7 MHz.

Note the equation:

$$\begin{aligned} \text{radio frequency} + \\ \text{intermediate frequency} = \\ \text{oscillator frequency} \end{aligned}$$

You will need this equation to understand the following material. I am going to start by discussing

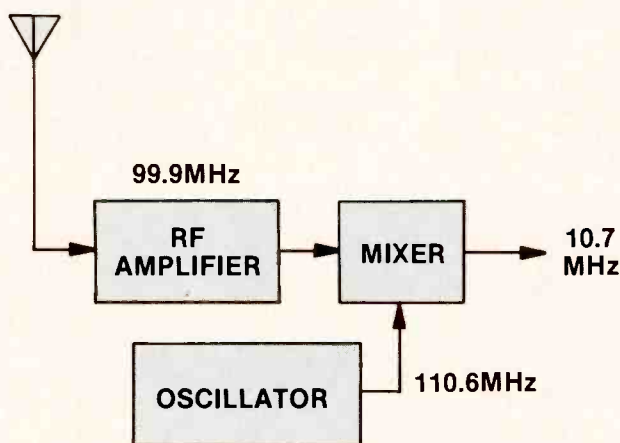

Figure 1.

$$\text{RF} + \text{IF} = \text{OSCILLATOR FREQUENCY}$$

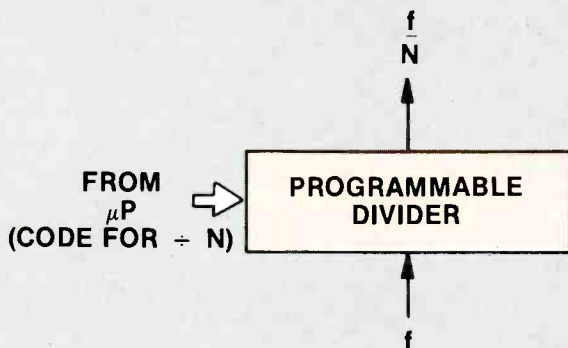

Figure 2.

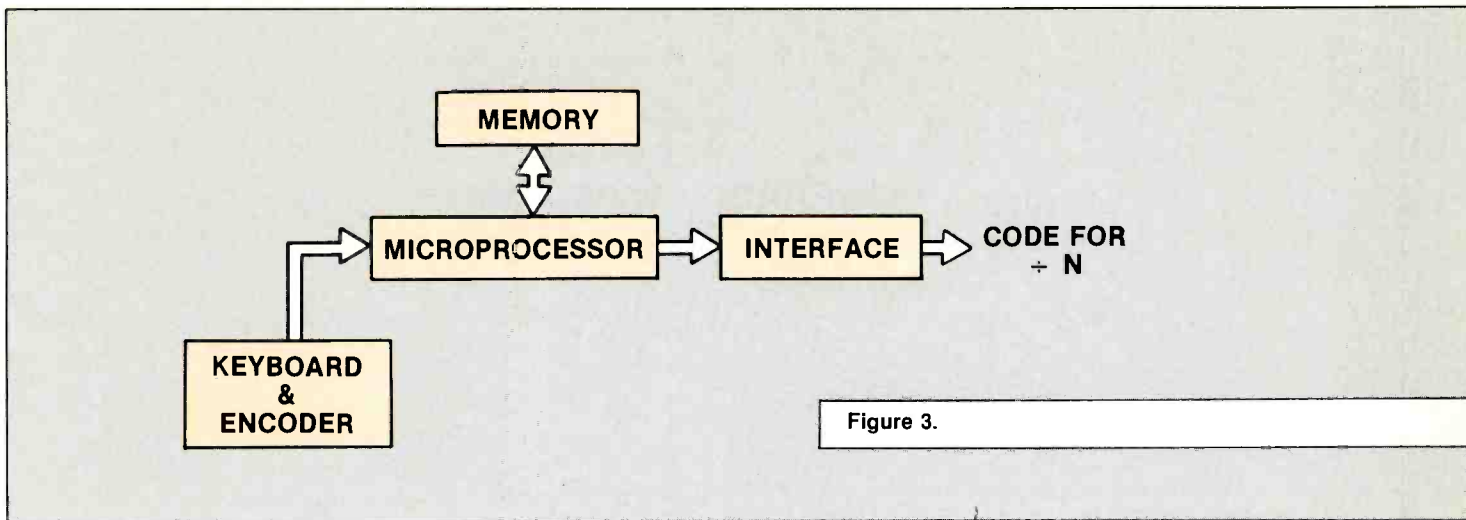

Figure 3.

the various parts of the tuner.

Figure 2 shows a *programmable divider*. Its purpose is to divide any frequency (f) by a whole number (N). The divisor is selected by a binary code that is delivered to the programmable divider from the microprocessor. In this system, there are 99 different channels, so there must be 99 different codes for selecting any of the available FM channels.

Figure 3 shows the keyboard and microprocessor system that is used for selecting the desired code to be delivered to the programmable divider.

If you have read any of my material on microprocessors, you know that I insist that it is nothing more than a device that implements memory. As a matter of fact, that was the original reason for re-designing the microprocessor. The memories were becoming so complicated that the electronic circuitry needed for implementing them was getting out of hand. The microprocessor makes it possible to utilize the memory with a minimum amount of associated circuitry.

The various binary codes for setting the programmable divider are stored in the memory.

The keyboard and encoder make it possible for the consumer to select the desired station. Any keyboard number less than 88.1 or over 107.9 will be rejected by the microprocessor. The encoder converts the numbered keyswitch into a binary code that can be used by the microprocessor. That binary code tells the microprocessor to get a certain number out of memory and deliver it to the programmable divider.

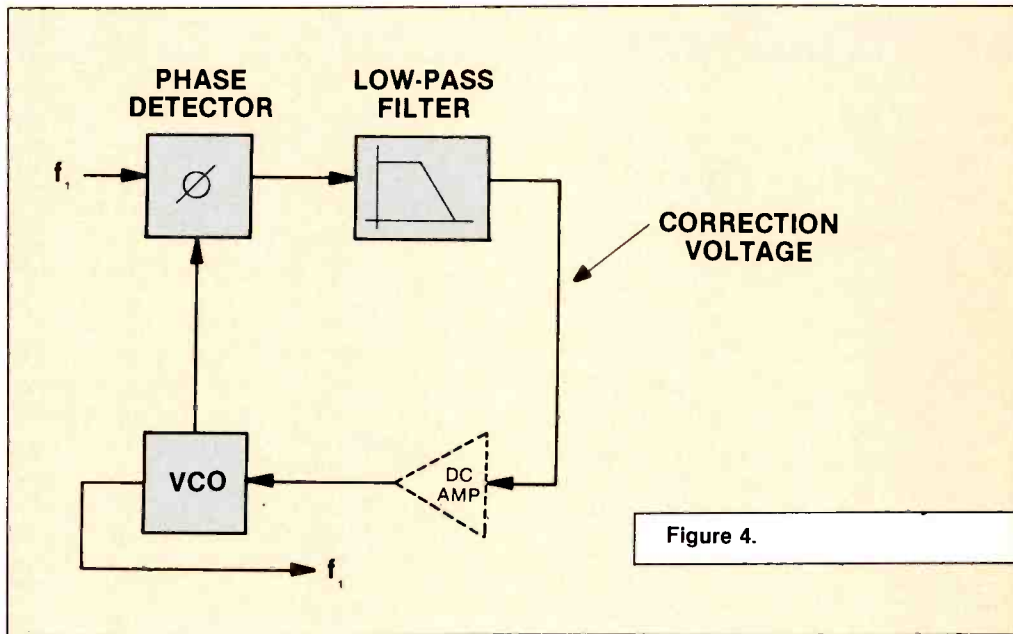

Figure 4.

The keyboard is the weak link in this tuning system. In fact, the complexity of the keyboard may be well beyond the comprehension of the average listener.

Figure 4 shows a typical *phase-locked loop*. The input frequency (f_1) comes from a stable oscillator source. The first block in the loop is marked with the Greek letter ϕ , which stands for phase comparator.

The output of the voltage-controlled oscillator (VCO) and the reference frequency (f_1) are compared in the phase comparator. The output of the phase comparator is a dc voltage with a magnitude that depends upon the amount of phase difference between f_1 and the VCO signal. If there is no difference between these two frequencies, the output of the phase comparator will be 0V and no correction will be made. If,

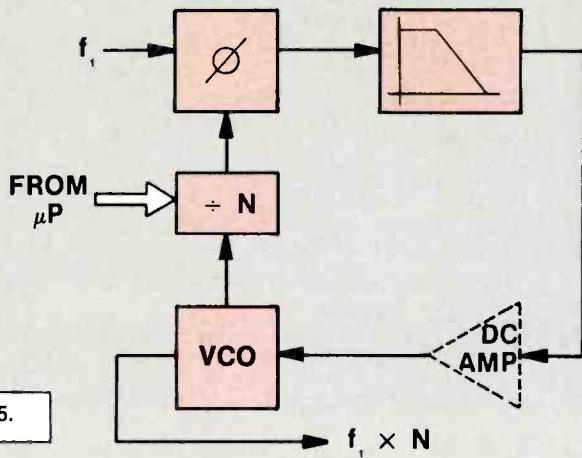

Figure 5.

however, there is a phase (or frequency) difference between f_1 and the VCO signal, a dc output voltage will appear at the output of the phase comparator. That voltage is used for correcting the VCO frequency.

The next block in the loop is a low-pass filter. The symbol shows a typical low-pass filter characteristic curve. This filter prevents f_1 and the VCO frequency from being passed around the loop.

The next step in the loop is a dc amplifier. It is drawn with a broken line because not all phase-locked loops have this amplifier. Its obvious purpose is to increase the range of the dc correction voltage before it is delivered to the VCO.

When the VCO frequency is identical to the incoming reference frequency, there is no correction from the dc amplifier (or, from the low-pass filter) and the VCO output is equal to f_1 . Not much has been accomplished because the output frequency is the same as the input frequency.

In Figure 5, a programmable divider ($\div N$) has been added to the loop. Remember that the input to the phase detector must be two frequencies that are identical. Suppose that $\div N$ is set to divide by 2. (This is not a practical number in the real tuner, but we are using it for an example to show how the VCO is affected.)

If you divide the VCO frequency by 2, then it is obvious that the VCO frequency must be exactly twice f_1 . Then, when it is divided

by 2, it will be exactly equal to f_1 . Therefore, the VCO output would be 2 times f_1 in that simple example.

Regardless of what value of N the microprocessor sets the programmable divider for, the output frequency from the VCO will be N times the input frequency.

The reference input (f_1) may come from a crystal-controlled oscillator. So, by using the phase-locked loop with a programmable divider, the crystal oscillator frequency can be multiplied by any number set by the microprocessor.

The important feature of the circuit is that the VCO output is highly frequency-stable because of the crystal input at f_1 . In other words, you can have a wide variety of crystal-controlled output frequencies with this simple circuit.

Figure 6 shows the phase-locked loop for producing the crystal-stabilized local oscillator frequency of 110.6MHz as shown in Figure 1. A 200kHz crystal oscillator is used for stability in the circuit of Figure 6. That crystal oscillator frequency is divided by 8 to produce a 25kHz input to the phase detector.

For the phase-lock to be stabilized, it is necessary that the input from VCO also be 25kHz. To obtain that, the programmable counter divides the VCO by 553 and the prescale $\div 8$ circuit divides the VCO output by 8.

If you have your calculator handy, you will see that the VCO must be operating at 110.6 so that when it is divided by 8 and then by 553, the result will be 25kHz. That will match the 25kHz from the crystal circuit and a phase lock will be obtained. If the VCO should try to drift off frequency, the output from the phase comparator will send a correction voltage through the low-pass filter and bring the VCO back to the proper frequency. Note: There is no dc amplifier in the phase-locked loop of Figure 6.

If the listener tunes to another station, the input from the microprocessor always will set the programmable divider so that it divides by the proper amount in order to get a phase lock. The output of the VCO then will be the proper frequency for the tuned station.

Dichotomy

Reader Terry Bohning has pro-

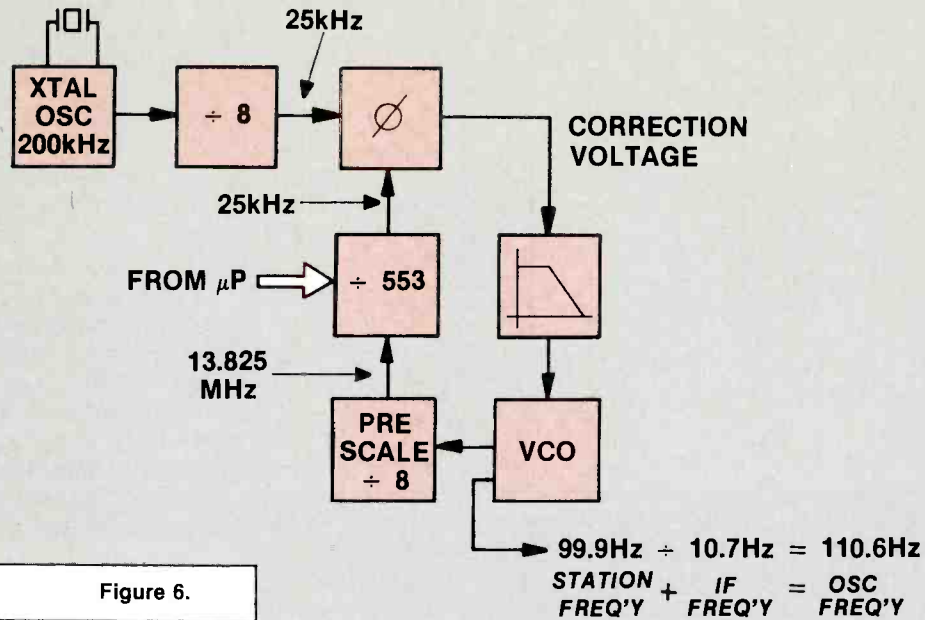

Figure 6.

posed a different and interesting answer to Question No. 6 of the quiz in the August 1986 issue.

Here is the question and the answer given:

6. Connect the coils and battery

circuit in Figure A to obtain maximum flux in the iron core. The solution given in the August issue is shown in Figure B.

Terry Bohning writes: "Given some of the trickery in past

ELECTRO DYNAMICS, INC.

898 Route 106 - East Norwich, N.Y. 11732
 Order Toll Free 1-800-I-AM-NICE or 1-800-426-6423
 In N.Y. state call collect (516) 922-4380

**75 to 300 OHM
 Matching Transformers**
 .19¢ Each

**4.7/350 Volt
 Radial Lead
 Capacitor**
 (P.C. Board Type)
 .29¢ Each Any Quantity

**Original Sanyo
 2SD-1341P**

Replaces ECG238 or ECG165
 Only 1.39 each Any Quantity

ORIGINAL MAGNAVOX CRITICAL SAFETY CAPACITORS

**Sanyo & Fisher
 R.F. MODULATOR**
 Fisher Part #4-1164-03160
 Sanyo Part #143-9-4300-57500
 66% off **ONLY 14.95 Each.**

#250-663-11	.0086-160015%
#250-663-13	.0096-160015%
#250-663-17	.0185-120013%
#250-663-18	.0135-160015%
#250-663-19	.0195-120013%
#250-663-20	.0235-120013%

ONLY 2.99

We carry a complete line of TV, audio and video parts.
 To guarantee these low prices you **must** mention this ad
 when ordering.

Order Toll Free **1-800-I-AM-NICE** - In NY State call
 collect 516-922-4380

Circle (17) on Reply Card

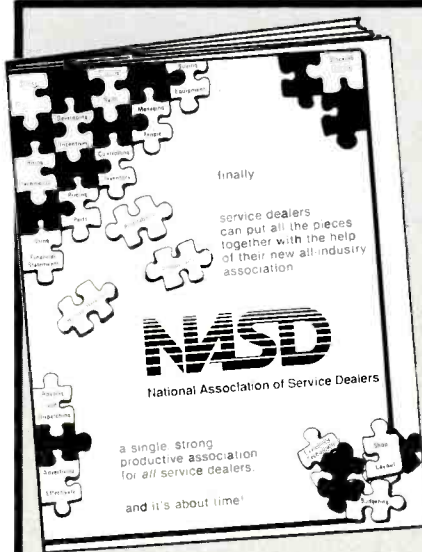

the most
 important
 "service
 manual"
 any dealer
 could have...

the NASD
 Catalog of
 Member
 Services...
 dozens of proven
 programs and
 services to
 increase
 your profits!

Mail to: **NASD** Suite 310, 10 E. 22nd St., Lombard, IL 60148
 or call David Ashton, Managing Director, at 312/953-8950

Please rush me a free copy of the Catalog of Member Services and
 full details on how NASD membership can improve my business.

Name _____
 Firm _____
 Address _____
 City _____ State _____ Zip _____
 Phone _____

Circle (18) on Reply Card

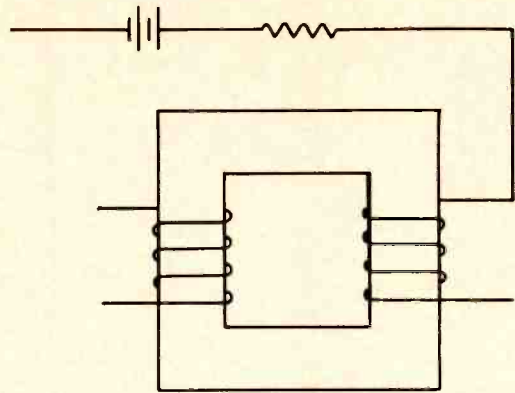

Figure A.

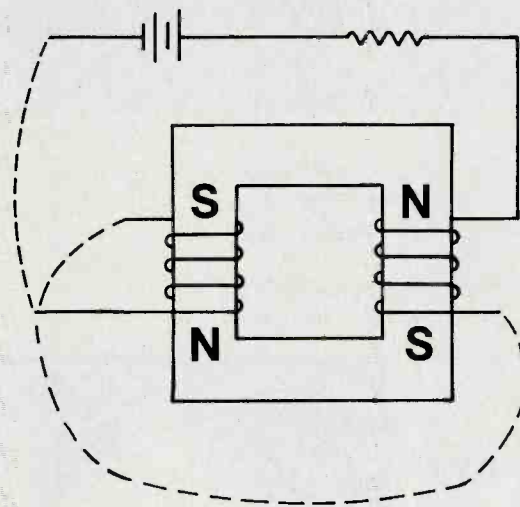

Figure B.

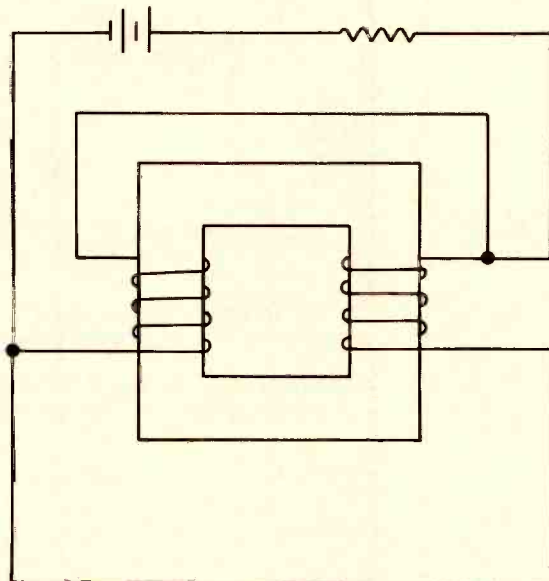

Figure C.

quizzes, I was a little surprised not to see the following answer to Question No. 6 in the August 1986 quiz (see Figure C). This produces a slightly greater current in the coils, hence flux density."

This is not the first time there has been a practical answer proposed to a theory question.

As I see it

There is no resistance value shown on the coils in Figure A, so it must be assumed the resistance is zero. As far as circuit current is concerned, it doesn't matter whether you connect them in series or parallel.

Also, "maximum flux" means (to me) that the core is saturated. There can only be two possibilities: coil fluxes aiding (for saturation), or coil fluxes opposing (for zero flux).

As Terry Bohning sees it

From a practical standpoint, coils have some resistance whether stated or not. Connecting the coils in parallel will produce an increase in current and a resulting increase in flux. (He does not read *saturation* into the expression *maximum flux* as stated in the problem.)

Summary

If the parallel connection does, in fact, cause a greater flux than the series connection, then it must be assumed that the coil resistance is an appreciable part of the circuit resistance. This assumption is not supported by any information given in the problem.

If the question was worded in such a way that you had to make assumptions about coil resistance in order to get the answer, it would really be a trick question!

It doesn't matter whether you think of flux as being saturation or just a large amount, the series or parallel connection does not affect the answer. It really is a matter of whether you want the flux to go to zero if a coil opens (series), or, whether you want some flux to be present when a coil opens (parallel).

Terry Bohning has given an interesting and different way of looking at a question. I feel that his answer is as good – but not better – than the one given in the August issue.

(Trickery? I'm crushed.) **ES&T**

Troubleshooting Tips

Fuse blows instantly

Bohsei TC-700

(Photofact 1762-1)

A local TV technician asked my help with this Bohsei receiver that instantly would blow fuse F3. He had checked everything except the flyback. I ring-tested the flyback, found nothing wrong, and made some resistance tests around F3 looking for shorts. No shorts were found.

Finally, I replaced F3 and connected a 100W incandescent light bulb in series with one side of the ac line to the receiver, so I could monitor the line current and apply power without blowing F3 again. At first, the bulb glowed brightly, but it dimmed as the degaussing circuit increased in resistance. Then, the bulb began flashing erratically, and an arcing sound came from around the horizontal-output transformer. Quickly, I switched *off* the room lights and saw an arcing from the horizontal-output transistor through the mica insulator to ground.

Replacement of the mica insulator and insulating sleeves *stopped all arcing* at full line voltage and restored *normal operation*.

David M. Luckner
Corning, NY

Erratic starting

Panasonic CT309

(Photofact 1924-1)

This Panasonic was brought to me by another technician, after he had given up on the repairs. The television receiver was difficult to turn *on*. The *on/off* switch had to be pulled and pushed a few times before the set would start. Then after it started operations, the receiver would work all day, even if turned *on* and *off* several times during the day. But next morning, it would not start on the first try.

First, I checked the power supply, but it was normal. Next, I checked the voltages around IC401 pins 16, 15, 14, 13 and 12 because they appeared to have importance for the horizontal oscillator and the horizontal pre-drive. All pins had normal dc voltages except pin 12, which had zero voltage instead of the normal +2.25V. Scoping pin 14 showed the usual sawtooth waveform, but nothing was at pin 12.

From these tests, I concluded that IC401 was bad, so I replaced it. Each time that day the receiver was turned *on*, it began operation without problems. And next morning, the TV started working the first time I pulled the power knob. Apparently, it was repaired, so it was returned to the customer.

Just a few days later, the set was returned to my shop accompanied by the same complaint: It would not start the first time. I started by checking the dc voltages at the IC401 pins. All were normal except pin 12 that remained zero. Pin 12 has only two resistors and the base of Q501 horizontal-driver transistor connected to it. Both resistors tested in

tolerance. I removed Q501 to make certain base current was not bleeding all the pin 12 voltage. The pin 12 voltage remained at zero.

Now I didn't know what to do. This seemed like a dead end. Perhaps the exchange IC401 might have gone bad, but it is almost impossible for two ICs to fail in the same way when there is no external overload. My experience has shown me that an overload in the vertical circuits can kill the high voltage. Therefore, I returned to IC401 and checked all pins that are used for vertical oscillator or vertical driver. All those pins checked near normal except pin 11, which should measure 0V but had some voltage. I didn't know if this was normal or not for a receiver that was dead, but it was the only hint I had. (Pin 11 apparently is part of the "S" filter that corrects stretched linearity at top and bottom of the raster.) I noticed an electrolytic capacitor (C457 10 μ F) between pin 11 and ground, and I know open electrolytics cause many mysterious symptoms. First, I paralleled C457 with a known-good one and it solved the problem. *Then I replaced the C457 capacitor and the color receiver worked normally, with dependable start-up when it was switched on.*

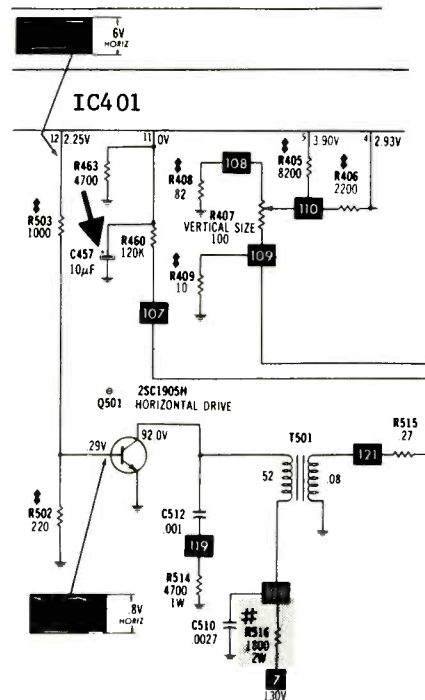

The entire "S" filter consists of R460, C457 and R463. R460 (120K Ω) connects pin 11 and the vertical-yoke signal. R463 (4700 Ω) connects pin 11 to ground. And 10 μ F C457 is between pin 11 and ground. C457 ordinarily rounds the corners of the vertical signal and reduces the amplitude of the vertical pulses. But when C457 is open, the sharper, higher amplitude tips of the vertical pulses come to pin 11 in such excessive amplitude that they cause solid-state conduction inside IC401 (this accounts for the dc voltage found at pin 11 when it would not start). Also, something else happens that eliminates the horizontal-drive signal at pin 12. We cannot explain that, because the circuitry is inside the IC.

Samuel Martinez
Bayamon, PR

A wedding occurred several years back. Amid much media hype and great expectations in the home entertainment industry, video married audio.

Within a few months, the marriage was on the rocks. People with their new audio-video control centers hooked into high quality stereo systems discovered just how bad VCR audio was. With a frequency response just a little bit worse than an early '70s portable cassette recorder, and flutter figures so high you got seasick listening to it, VCR audio was better left fed through the 4-speaker of a cheap TV set. A/V control centers across the country were turned off.

But manufacturers rallied. They split the single noisy audio channel into two doubly hissy ones, added noise reduction, and called it stereo. It did sound a little better, but nothing was done to eliminate flutter, and noise reduction does not improve frequency response. In SLP (6-hour) speed, the sound was still virtually intolerable. All the same, we grumbled and put up with it. What else could we do?

Then some engineer pondered, if we can record a video signal with a 3MHz bandwidth, using helical scan and rotary heads, why not do the same for the 20kHz wide audio spectrum? As a matter of fact, something similar had already been done on the laser video disc. Well, the Beta and VHS people got to work and produced two audio FM systems with similar performance specifications, but differing executions, based upon the limitations of each format.

Before we go any further, let's recap the specifications for the VCR hi-fi formats. Frequency response is typically 20-20kHz, with distortion under 0.5%, a S/N ratio of better than 80dB and flutter/wow figure around 0.005%. The latter, in particular, is about three orders of magnitude better than normal VCR audio. As a matter of fact, judging by specifications, VCR hi-fi is second only to compact disc in performance. This major improvement in sound adds greatly to the enjoyment of video tapes and brings us closer to the goal of the home theater.

Both VHS and Beta hi-fi use audio frequency modulation (AFM) to record sound using the rotary heads. Both use noise reduction to boost S/N ratio. Neither allows you to audio-dub the hi-fi tracks, because the audio and video are mixed together before being laid down on the tape.

As shown in the frequency spectrum diagram, Beta, by shifting the luminance carrier +400kHz,

has made some space between the chroma subcarrier and the lower sidebands of the recorded luminance signal. Surprisingly, this shift does not create compatibility problems with non-hi-fi machines. VHS uses a different approach, which is termed *depth-multiplex* recording. The audio carriers are recorded first, then the video is laid down on top of them. At first thought, you'd expect the audio information to be erased and lost. But circuit characteristics and head azimuth are chosen so that just enough AFM can be recovered from the RF envelope.

An analogous situation can be observed on an audio cassette deck with low erase bias. If you try to erase previously recorded information, the high frequency material may be totally eliminated, while low frequency signals remain. Because the highest AFM carrier, at 1.7MHz, is half the lowest excursion of the luminance carrier, at 3.4MHz, VHS hi-fi capitalizes on this effect and gives it the fancy name of depth multiplexing.

Beta uses the same heads for video and audio. Four audio carriers are utilized, one left and one right for each head. VHS, on the other hand, has two separate audio heads on the rotary disk, and needs only two carriers, one for left, and one for right. So, the VHS engineers traded electronic for mechanical complexity. Part of the reason was the limited spectrum space available in the VHS format. Thanks to a higher writing speed, Beta could shift the luminance carrier up and make some space for the audio. VHS already has the Y carrier about as high as can be, given the slower relative tape-to-head speed.

But why does Beta need twice as many carriers as VHS? The answer is based on the fact that the same heads that record video are used for audio. Those of you familiar with the azimuth recording system used in both formats are probably aware that the A and B heads are tilted several degrees in opposite directions. This reduces the amount of B-signal pickup by the A head, and vice versa. But the azimuth cross-talk reduction scheme is frequency dependent, with higher frequencies being more sensitive to it. With the Beta azimuth optimized for the luminance carrier, the cancellation effect was not nearly as great at AFM frequencies. So, to reduce audio crosstalk, Beta has to use two separate frequencies per audio channel, one for the A head, one for the B. Of

HiFi CARRIER FREQUENCIES

Carrier	Frequency	Video Track	Audio	Luminance
Beta	f1	1.38MHz	A	4.25 ± .75MHz
	f2	1.53MHz	B	
	f3	1.68MHz	A	
	f4	1.83MHz	B	
VHS	f1	1.3MHz	NA	3.9 ± .5MHz
	f2	1.7MHz	NA	

BETA HiFi FREQUENCY SPECTRUM

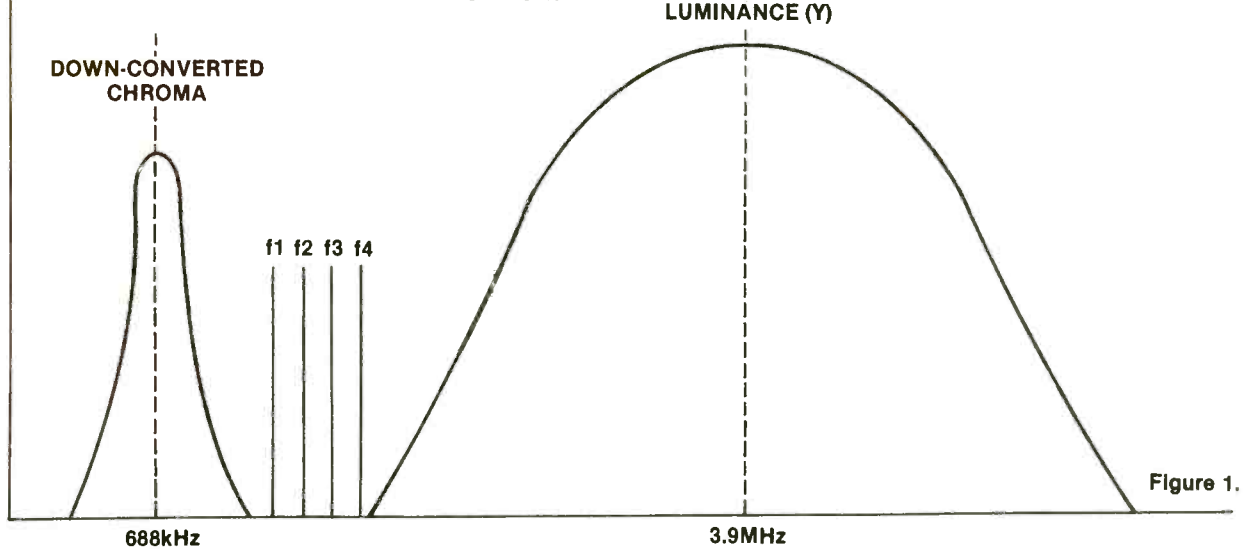

Figure 1.

course, VHS, with separate heads for AFM, can optimize the azimuth on them without worrying about the video signal.

Both formats must pre-emphasize and compress the audio signal before modulation and recording. In playback, the signal is reconstructed using de-emphasis and expansion. This is the Achilles heel of VCR hi-fi. Unlike the compact disc, which has an inherent S/N ratio of 96dB, the AFM system used by Beta and VHS has a raw value closer to 45dB. Fortunately, the use of RMS level detectors makes it difficult to hear the noise reduction working.

Sound quality was also of major concern to the

formulators of the 8mm video format. The standard call for a monophonic AFM channel recorded along with the video signal, just as on the 1/2-inch hi-fi machines. But, to the increased satisfaction of audiophiles, space for two PCM (pulse-code modulation) channels also was allocated. So the new format actually can support three channels of high fidelity audio along with the video information. As a matter of fact, machines are already on the market that use the entire width of the 8mm tape to record audio. The maximum playing time for this scheme is 24 hours. You'll see more about PCM audio right here, next time.

ES&T

ATTENTION TECHNICIANS

- ★ JOB OPENINGS
- ★ MONTHLY TECHNICAL TRAINING PROGRAM
- ★ BUSINESS MANAGEMENT TRAINING
- ★ LOW COST INSURANCE
- ★ CERTIFICATION
- ★ TECHNICAL SEMINARS

All of this in a nonprofit international association for technicians

FIND OUT MORE:



604 N. Jackson St.
Greencastle, IN 46135



FREE CATALOG SERVICE TOOLS & TEST INSTRUMENTS

Packed with over 5,000 quality products for testing, repairing, and assembling electronic equipment. A full selection of test instruments, power protection equipment, precision hand tools, tool kits, soldering supplies, and much more. Products are shown in full color with detailed descriptions and pricing. All products come with a 100% satisfaction guarantee. SAME-DAY shipment program.

In a hurry to receive your catalog?

Call (800)-225-5370

In Massachusetts call (617)-682-2000

Contact East, Inc., Dept. R401
P.O. Box 786 No. Andover, MA 01845

Circle (19) on Reply Card

Put Your Electronic Skills to Work in ROBOTICS NOW!

BECOME A
**ROBOT VEHICLE
PILOT/TECH**

Financial Aid
Placement Assistance



**HIGH PAY
HIGH TECH
EXCITING CAREERS**

**Electronic, Hydraulic &
Robotic Skills Taught.**

Call or Write for
FREE BROCHURE TODAY.

Ask About Our
Correspondence Course
(713)690-0405

UNDERWATER VEHICLE TRAINING CENTER
10046 Chickasaw, Houston, TX 77041

Circle (20) on Reply Card

Products

Portable oscilloscope

Tektronix has broken the \$1,000 price barrier with the introduction of the newest member of the 2200 series of portable oscilloscopes.

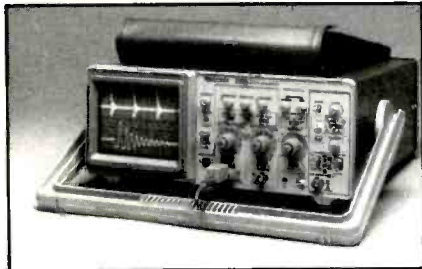

The dual channel 2225 portable oscilloscope features 50MHz bandwidth, alternate magnification, 500 μ V sensitivity, peak-to-peak auto trigger mode, and high frequency/low frequency trigger filtering.

Circle (75) on Reply Card

Facilitate VCR repair

Howard W. Sams & Company, a division of Macmillan, has published "VCRfacts," technical service documentation for videocassette recorders. The data provide repair information for popular VCRs and are compiled in the Photofact standard notation format. Other elements include: color coding of test point locations/voltage measurements, and Sams' Grid-Trace that offers an exclusive method of reading schematics and locating components with "road map" coordinates. Waveforms are easy to read, according to the publisher, and there is a replacement parts cross-reference.

Circle (77) on Reply Card

Personal computer service kit

Jensen Tools has designed a tool kit for owners of personal computers and related peripheral equipment. The JTK-9 PC service kit enables the non-technical user of most personal computers to remove and install unit covers, circuit boards, memory chips, cables and connectors, and to perform other routine maintenance tasks with ease.

The tool selection includes a

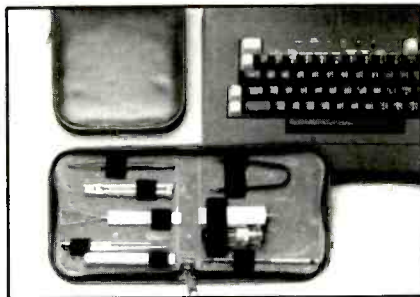

screwdriver handle with four interchangeable blades, CMOS-safe IC insertion and extraction tools (with built-in pin straightener), screwstarter, key cap puller, spudger/DIP switch setter, and a disposable penlight. Tools are contained in a 7"x7"x1" zipper case of padded vinyl with velvet interior.

Circle (78) on Reply Card

Clean backup power

Underwriter Laboratories approval has been granted to the DataSaver 400 Standby UPS, available from Cuesta Systems, for use in information processing and business equipment in an office environment (UL478). The product eliminates power problems for the microcomputer user. Backup power from the sealed gel cell bat-



tery is instantly available in case the ac line power from the utility company fails. Overvoltage transients are stopped, and EMI noise is filtered out.

Low-profile styling (13"x13"x2") allows the device to be stacked under the monitor or with other peripherals for space efficiency.

Circle (78) on Reply Card

Uninterruptible power refinery

Advanced Electronics Systems now manufactures an uninterruptible power refinery (UPR). The Stedi Watt UPRs come in two models—the SWD 450 with an output power of 360W (enough to power a typical IBM PC AT comfortably for 15 minutes) and the

SWD 750, which user reports confirm has supported two IBM PC XTs, a Compaq 286 LAN system, and a 75W Novell active hub safely through a 9-minute heavy storm blackout. Both models include built-in high energy modem protection, surge protection, EMI/RFI filtering and exclusive PSPL (pre-synchronized phase-locking) that ensures an accurate, reliable transfer to standby power within 4ms or 8ms.

Also unique to the UPR is Stedi Watt's diagnostic circuit/power monitor that identifies circuit



faults and verifies that power is computer grade while self-testing for any defects in its own protection circuitry.

Circle (79) on Reply Card

Conditioned uninterruptible power system

Kalglo Electronics has announced new modifications in its line of standby uninterruptible power systems (UPS). Designated Line-Saver models LS250, LS500 and LS750, they now are equipped with circuitry to detect miswired electrical outlets, a common source of data loss or contamination of computer files as well as actual destruction of computer microcircuitry.

The integrity checker function is implemented using the existing neon light that is internal to the power on/off switch on the front. The neon will glow when the power on/off switch is off and the hot and neutral wires are reversed in the power outlet, and not glow if the ground is not present at the power outlet regardless of the on/off switch setting. If the power outlet has both the hot and neutral reversed and the ground wire open, the neon light will not glow regardless of the on/off setting.

Circle (80) on Reply Card

ES&T

Readers' Exchange

Wanted: Vertical integrator, part No. 30-6030-9; vertical feedback, part No. 30-6539-1, for Philco B&W television, chassis No. 11N51. *Tabor Radio & TV, Box 56, Killdeer, ND 58640.*

For Sale: Sams Photofacts 541 to 681, 807 to 1007 plus 100 assorted older folders; Sams AR manuals AR34 to 58. Also 232 tubes, fast movers in early '70s. Everything in excellent condition. Details available. *Stanley Besecker, 7789 Oak Drive, Waynesboro, PA 17268; 717-749-5548, evenings.*

For Sale: Heathkit—tube checker ITH3117, CRT rejuvenator IT-5230, color-bar/dot generator IG-5228, 40kV HV probe meter IM-5210, variable ac power supply IP-5220, FET/transistor tester IT-121, logic probe IT-740, yoke/flyback tester IT-5235, capacitor and resistor sub boxes; PTS TV tuner analyst (new) No. 2022; Knight-dc-5.2Mc 5-inch wideband oscilloscope KG-635, sweep/marker generator KG-687; 13-inch degaussing coil. All excellent, with manuals. Soldering irons; 100s of new parts and tubes; *Electronic Service* magazines, 1975-1986, and much more. Shop closing. Everything only \$950. *M. Hayden, 342 Farnsworth Drive, West Carrollton, OH 45449; 513-866-5983.*

Wanted: HV transformer for Magnavox, T809-10 chassis; Photofact No. 1477, reasonable. **For Sale:** B&K color-bar generator, model 1245, \$60 plus shipping. *4366 Eastport Drive, Bridgeport, MI 48722; 517-777-2494.*

Needed: Will pay for service information and/or schematic for radio cassette Crowncoorder by International of Japan, model CSC9350M; service information and/or schematic for cassette player by Crown, model CS-11; address of company to contact for special parts, service information and/or schematic for General Sound B&W television, model GS230, with back plate "Made in Taiwan, model 790." *Leo E. Smith, P.O. Box 945, Vet Home Section J, Yountville, CA 94599.*

Wanted: Sencore CR-70 beam builder in working condition—will trade three Fairchild 766-series oscilloscopes (one 766HF, 100MHz, and two 766H, 50MHz extra vertical plug-in) plus two scope carts. Some working, all repairable, and with manuals. *Snow, R.R. No. 2, Box 596, Yarmouth, ME 04096.*

For Sale: Hewlett-Packard 30MHz oscilloscope, model HP-170B, includes HP-162C dual-trace plug-in and delayed sweep/expanded sweep plug-in. High quality and versatile for bench use. All in good working condition. \$250 plus shipping. *Jm Kluge, 5951 S. Logan St., Littleton, CO 80121; 303-794-3988, home, or 303-674-5576, work.*

For Sale: Sencore PR57 Powerite variable isolation transformer and safety tester, \$250; Sencore TF46 Super Cricket transistor/FET tester, plus 39G85 Touch-Test transistor testing probe, \$250; Sencore DVM56A Micro-ranger DMM, plus DP213 Universal Meter RF detector probe, and HP200 50,000Vdc HV probe, \$500; other items. All equipment is like new, with associated instruction manuals. Send large s.a.s.e. for complete listing. *Clarence G. McKee, 9516 Zion Road, Rives Junction, MI 49277.*

Wanted: New or good used 12DGP4 CRT. *Jiraneck TV, Farmington, IA 52626.*

For Sale: *Short Wave Craft* magazines edited by Hugo Gernsback, February and March 1933, and October 1936. Best offer, proceeds go to student fund. *Klein High School, Attn.: H. Deanne, Electronics, 16715 Stuebner-Airline, Klein, TX 77379.*

Wanted: Operating and service manuals for Communication Power model CP300 CB unit; frequency counter FC70; frequency converter FA70. Will gladly pay for original or copies of manual. *Joe Kurata, 377 Santa Ana Ave., San Francisco, CA 94127.*

For Sale: Tektronix 465B oscilloscope, 100MHz, recently calibrated, includes two probes and manual, \$1,100. *Steve Stoeckel, 1001 South Independence Blvd., Charlotte, NC 28202; 704-375-8662.*

Wanted: Philco module H0BC and 9-160 Zenith, need not be new, but in working order; A17DAP4 picture tube for Philco; Commodore 64, working or not, cheap; flyback 528 for CTC 52. **Needed:** Sams Photofact folders, 1065, 1115, 1347, 1409, 1509, 1628, 1707, 1732, 1937, 2085, 2087. Also for Sampo 8704, MHF-190. Will pay for copying, or will buy original. *Dan's TV, 316 East Ave. E, Hutchinson, KS 67501.*

Wanted: B&K substitution box, model No. 2902. Please state condition and price. *John P. Caputo, GPO, P.O. Box 3175, Brooklyn, NY 11202.*

Needed: RCA transformer for CTC46 T402 No. 132622; Capri TC900; voltage divider 213137 XK25M. *Walt's TV Service, 379 Burns Road, Route 2, Millville, NJ 08332.*

Wanted: Philco Predicta 21-inch B&W television—either complete set or receiver only (receiver could be separated to 25 feet from CRT assembly via attached cable). Set not necessarily in working condition, but receiver must be repairable. Condition of CRT assembly and connecting cable unimportant. Also need service data for this set; model number unknown. Will pay any reasonable price. *Alan Ford, 1298 Academy St., Scranton, PA 18504.*

Needed: Complete kit No. 22T for NRI model 315 25-inch color television. *David Kinchlow, 1515 Walnut St., New Albany, IN 47150; 812-944-4097.*

For Sale: Textbooks, service manuals, magazines, radio and TV parts, 1,000 tubes at 85% off list price, 1,200 Tek-Fax diagrams \$50 plus shipping. Send s.a.s.e. for list. *M. Seligsohn, 1455 55th St., Brooklyn, NY 11219.*

Needed: GE picture tube 19VDCP22 or 19FXP22, used preferred. *Ray's TV, 4821 East View Drive, New Orleans, LA 70126; 504-246-6205.*

For Sale: RCA oscilloscope, model WO-230, excellent condition, \$45; frequency meter, SCR 221, electrified, excellent condition, \$50. *William J. Maida, 274 W. Sabal Palm Place, Longwood, FL 32779.*

For Sale: B&K 747 tube tester, B&K 530 transistor tester, Heathkit 10MHz dual-channel scope, \$175 each, all manuals included. *Bill Sloggy, P.O. Box 28, Park Falls, WI 54552; 715-762-4679.*

For Sale: Channel Master signal level meter, \$75; Sencore FE-20 multimeter, \$50; Leader LEM-73a multimeter, \$45; Sylvania CK-3000 test jig (more than 50 adapters), \$150; VIZ-28 ISO transformer, \$25; B&K 3010 signal generator, \$100; B&K model 2025 RF signal generator, \$100; Simpson 380M microwave leakage detector (new), \$200; B&K 470 CRT restorer (new), \$225; Sencore SG165 audio analyzer, \$400; Sencore VA63 VCR adapter (new), \$250. *John Toth, 2786 71st St. Court W, Bradenton, FL 33529; 813-795-2786.*

Needed: Harvard Electronics-Futtermann audio amplifiers, all models, mono/stereo, working/non-working condition. Also schematics. *J. Bag-nata, P.O. Box 26, Harleigh, PA 18225.*

For Sale: Leader LSW-330 sweep/marker generator, TV/FM, like new, \$300. *Interiors, P.O. Box 1413, Queens, NY 11372.*

Wanted: LBO-516 Leader scope, will pay \$550; Sencore Z-meter, will pay \$500; B&K SG165 stereo analyzer, will pay \$500. All must be in pristine condition. *Claude Radio & TV Service, 136 S. Sage Ave., Mobile, AL 36606; 205-478-5294.*

For Sale: New/old tubes at 85% off list. Send large s.a.s.e. for list. *Mitchell Electronics, 4 Golf Ave., Maywood, NJ 07607.*

For Sale: Old Precision Series CR-30 B&W picture tube tester, never used, \$60 includes shipping. *Paul Caputo, 637 W. 21st St., Erie, PA 16502.*

For Sale: Sencore CRT checker CR143, \$70; RCA marker adder, WR70A, \$50; Sencore TF26 Cricket transistor checker, \$75; Westinghouse dc voltmeter, year 1911, best offer; B&K model 465 CRT checker, \$35; WWII Navy destroyer bridge intercom, \$25; Hewlett-Packard 410C voltmeter, new condition, with 11036Aac probe and service manual, best offer. *Bill's TV Service, 153 W. Duell Street, Glendora, CA 91740.*

Wanted: Heath or equivalent harmonic distortion analyzer for audio; Heath precision audio generator, good condition. **For Sale:** Heath IT-5235 yoke/flyback tester with HV probe and manual, used very little. Will sell or trade for above. *Bob Zagrabelny, Electronic Servicing, P.O. Box 9554, Tulsa, OK 74157-0554; 918-445-1433.*

For Sale: Sencore VA48, like new, used only a few times, with manual, \$750. *Mark Kastner, 360 Chez Parree Drive, Hazelwood, MO 63042.*

For Sale: Hitachi 20MHz dual-trace oscilloscope, model V-202F with three combination probes, \$225; Global Specialties pulse generator, model 4001, \$150; Global Specialties function generator, model 2001, \$85; OK Industries logic probe, \$35; Beckman model 300 DMM, with probes, \$45; Heathkit 3-output power supply, \$45; Heathkit analog/digital circuit design trainer, ET-3100-B, \$45; Heathkit digital design exp., ET-3200-A, \$45; Heathkit microprocessor trainer, ET-3400-A, \$125; NRI electronic circuit designer, \$75; several Heathkit continuing education courses with parts. Add shipping. *David L. Lloyd, Route 1, Box 112, Monroe, NE 68647.*

Needed: Service manuals/schematics for all the following—Allied AM-FM home stereo, model 333; Sansui stereo amplifier, model AU-7500; Sansui AM-FM home stereo receiver, model 4000; Sanyo 4-channel, full quadraphonic AM-FM home stereo receiver, model DCX-3500K; Kenwood AM-FM home stereos, models KR-4200 and KW-50; Masterwork reel-to-reel tape recorder, model M-808. *Kenneth L. Mixon, 401 E. San Pedro Ave., Perry, FL 32347; 904-584-2116.*

ES&T

Different strokes for different computers

Before you attempt to service a computer, it's really best if you first understand the rudiments of the operation of that computer. If you don't understand how the computer is designed to operate, you may not only be unable to diagnose any existing problem properly, you could even introduce serious problems that did not exist until you got involved.

Differences in internal programming

Many computers have no programs built-in, other than a program to activate the disk drive and read in a program from a floppy disk. Other computers have an operating program and sometimes a BASIC programming language built-in in read only memory (ROM). Still other computers have operating programs built-in so that all you have to do is plug the computer in, turn it *on* and select, say, a word processing program, a spread sheet program, or whatever.

As a specific example, if you turn an Apple II computer *on* and want it to do anything at all, you must have a disk drive connected, loaded with a disk that has the disk operating system (DOS) program written on it. This disk is supplied with the computer.

The only software built into the Apple II is the disk *boot* program. This is a program that's activated when the computer is turned *on*. This program activates the disk drive and causes it to read the disk operating system (a program that the computer uses to operate and to make the disk drive operate properly). Without this program installed, the computer will do absolutely nothing. Then, if the operator wishes to write a program in the BASIC programming language, he must call up that program from the disk by typing the appropriate instructions. The computer will respond by loading BASIC from the disk.

By contrast, the Commodore 64 has the computer's operating system and the BASIC programming language built-in in ROM. With this approach, when you turn the Commodore *on*, even if you don't have a disk drive connected, the monitor screen will, within a few seconds, light up with the message, "***Commodore 64 Basic V2** 64K RAM System 38911 Basic Bytes Free."

Not only does the Commodore have the BASIC program built-in, the disk drive itself contains its own microcomputer with ROM containing the disk operating system, so that it's not necessary to load the DOS into the computer because the computer only communicates with the disk drive; it does not operate it. This approach is called *distributed intelligence*, and the computer-controlled disk drive is called an *intelligent peripheral*.

Each of these systems has advantages and disadvantages and neither is clearly superior, but it is important to keep the differences in mind.

If, for example, you're trying to troubleshoot an Apple II and forget to put in a disk when you turn it *on*, you might spend a great deal of time trying to figure out why nothing's happening when the problem is simply that the computer has no instructions. If, on the other hand, you forget yourself and put a disk into the Commodore disk drive before turning that disk drive *on*, you might lose some data or even damage the disk and/or the drive.

To boot or not to boot?

These differences between the two approaches to storage and operation of the operating system lead to differences in vocabulary. For example, people who have been introduced to personal computers by way of Apple will speak of *booting* the disk. People who got their personal computer basic training on a Commodore rarely, if ever, use the term "boot."

To boot the disk means to turn the computer *on* with the DOS/BASIC disk in the disk drive. Then, a small program stored in the computer in ROM operates the disk and reads the disk's contents into the memory so that the computer can operate.

The term "boot" goes back to the early days of computers, when there was no such thing as read-only memory. When a computer of that era was installed, its memory, made up of magnetic cores, was completely blank. The computer was a useless hunk of metal at that point. In order to get the computer to do anything, it was necessary for the customer engineers to place information in memory by writing to the magnetic cores a few bytes at a time until the computer had enough information stored so that it could be instructed to read its software in from whatever medium the software was stored on.

This process of laboriously installing software a few bytes at a time was considered to be similar to pulling oneself up by one's bootstraps — hence the process is called bootstrapping or booting.

Other differences

Again contrasting the Apple II and the Commodore 64, there are considerable differences in how they are programmed to operate. If you're trying to type a program into the Apple II, for example, and you make an error, in order to correct it you have to press RETURN, re-enter the line number and re-type the line. With the Commodore, which features screen editing, you can back up and make whatever corrections are necessary. If what you're entering into the computer is in quotes, though, some strange things may happen when you try to edit.

Have the operating manual ready

Unlike TVs, stereos and other consumer products that operate more or less the same, personal computers vary widely in their operating characteris-

tics. When you're trying to troubleshoot a personal computer, you should, of course, have on hand the technical information: manufacturer's service data, Sams Computerfacts, etc. But if the computer you're working on is one that's not intimately famil-

iar to you, make sure the operating manual is also handy. It will help you differentiate between correct and incorrect behavior when you're observing symptoms. And it might keep you from inflicting unintentional damage on the computer.

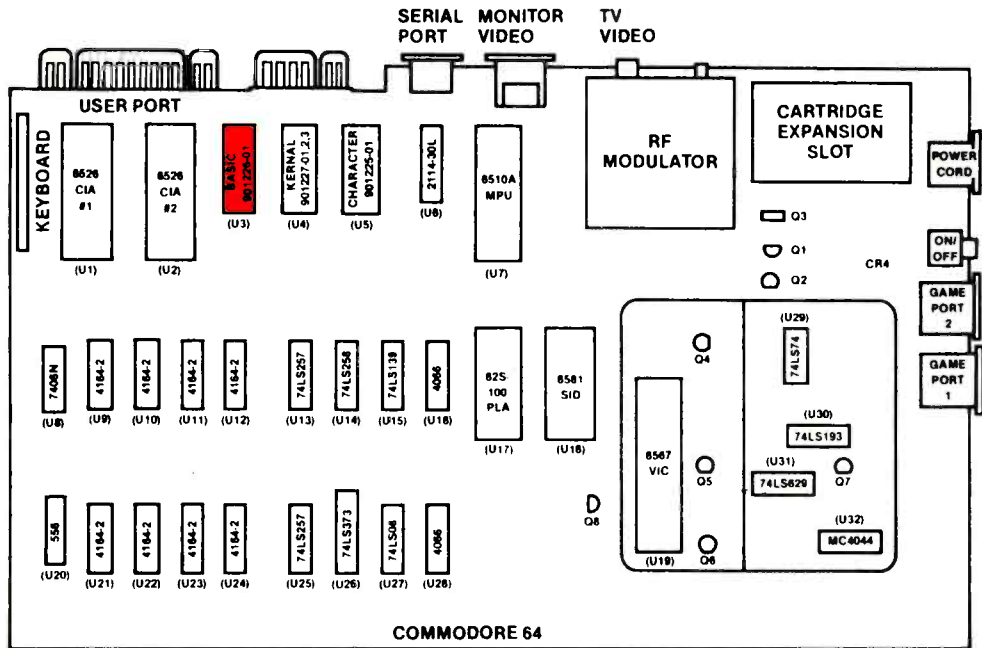

On some computers, like this Commodore, the operating system and BASIC interpreter are stored in ROM. In this top view of the computer's main PC board, U3, shown in red, contains the BASIC program.

NESDA Computer Group

COMPUTER SALES AND SERVICE DEALERS
WORKING TOGETHER

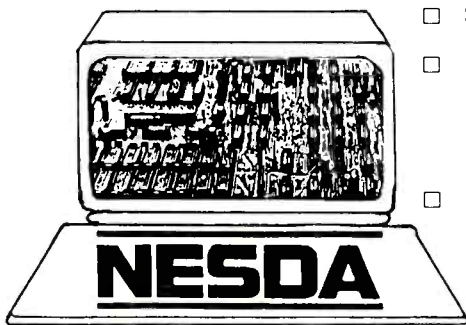

- Service training.
- Assistance in selecting in-house equipment and software.
- Specialized software for service management.

- Factory contacts for service literature and parts.
- Involvement in a stable and productive national trade association.

FOR MORE INFORMATION SEND BUSINESS CARD TO:
NESDA COMPUTER GROUP, 2708 WEST BERRY STREET
FORT WORTH, TEXAS 76109; PHONE (817) 921-9061

MAKE ANY TELEVISION OUTPUT STEREO SOUND!!

Increase your profit margins by selling and installing this unique device.



Model SS-2001: The TELEVONIC™ implant unit, installed directly into any Television, creates synthesized stereo output from any channel. When connected with a stereo amplifier or receiver, it will provide a sound system found only in expensive stereo Televisions, at a fraction of the cost.

Works on any TV • Easy to install • 100% Solid State • Microchip technology • Superior Sound quality • 1 year warranty.

REQUIRES QUALIFIED TECHNICAL INSTALLATION.
DISTRIBUTOR INQUIRIES WELCOMED.

For Information Contact: Mr. Ernest C. Hassell • Director of Marketing
• Spectrum 2000, Inc. • 4854 Sterling Drive • Boulder, CO 80301
• 1-800-922-6333

TELEVONIC is a trademark of Spectrum 2000, Inc.
Manufactured in the U.S.A. by Spectrum 2000, Inc.

Circle (21) on Reply Card

Symptoms and cures compiled from field reports of recurring troubles.

Chassis—Philco E06/E21
PHOTOFACT—1609-1

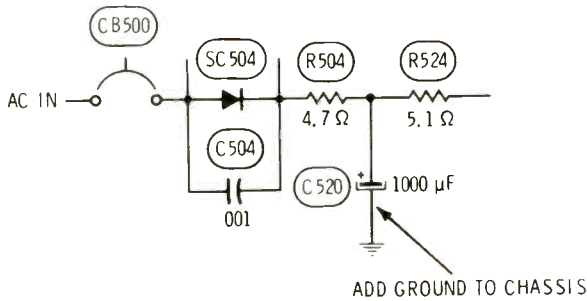

Symptom—Soft hum at low volume settings
Cure—Add a ground lead from C520 to chassis

Chassis—Philco E06/E21
PHOTOFACT—1609-1

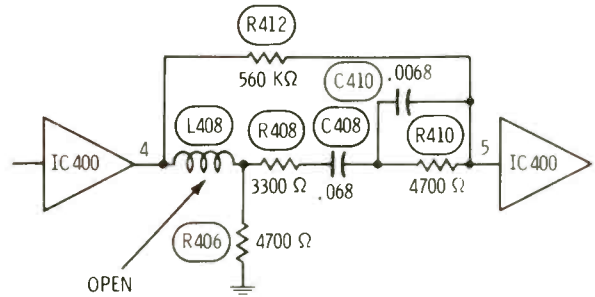

Symptom—Intermittent vertical or horizontal locking
Cure—Check L408, and replace it if open

Chassis—Philco E06/E21
PHOTOFACT—1609-1

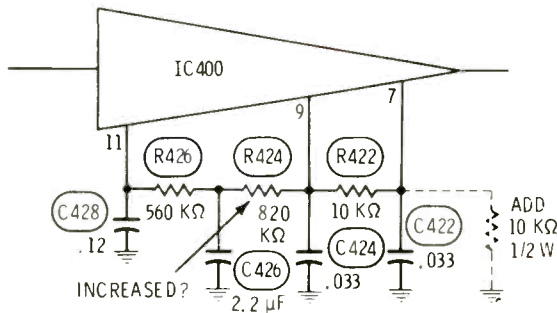

Symptom—Picture (not raster) shifted to the left
Cure—Check R424, and replace it if increased. Also, add a 10K resistor as shown

Chassis—Philco E06/E21
PHOTOFACT—1609-1

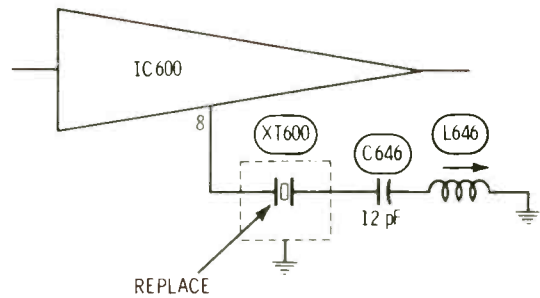

Symptom—As set warms, tint changes toward green
Cure—Replace the 3.58-MHz crystal, XT600

Chassis—Philco E20/D21
PHOTOFACT—1585-2

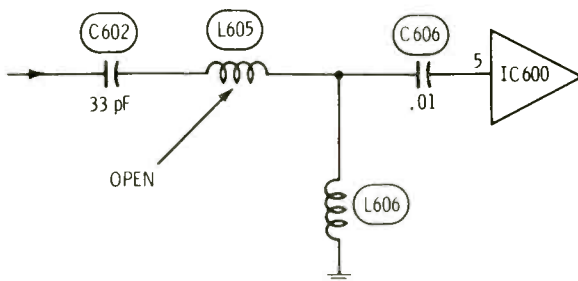

Symptom—No color or weak color
Cure—Check L605, and replace it if open

Chassis—Philco E06/E20/E21
PHOTOFACT—1609-1 or 1585-2

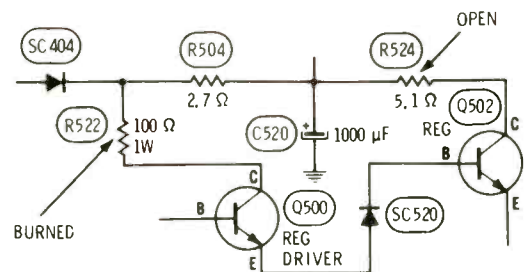

Symptom—R22 burned or operating hot and no raster
Cure—Check R524 and Q502, and replace if defective

Answers to the Quiz

1. C. The video camera device was announced by Toshiba. It is described on page 12 of the July 1986 issue.

2. C. "What Do You Know About Electronics?" by Sam Wilson (page 52). Although many readers wrote to explain gamma, and the use of gamma in designing follower circuits, they have not convinced me that gamma is an important parameter. Of course, this is a matter of opinion. Some of the letters I received disagree with that opinion.

3. A conductive elastomer. This material serves two purposes. It holds the component in place and it completes the electrical connection.

4. D. The 19kHz pilot signal is within the frequency range of tweeter speaker response. The signal may be overloading the speaker, but the customer may not

be able to hear the offending frequency. Refer to page 64 of the July 1986 issue, "Audio Corner," by Kirk Vistain.

5. B. The lower the number, the better the receiver is able to reproduce weak signals. However, the rating is misleading because the reproduced sound may have excessive noise when the receiver is working with very low amplitude signals. A better rating is decibel quieting. Refer to page 64 of the July 1986 issue, "Audio Corner," by Kirk Vistain.

6. A. The decibel quieting of an FM receiver tells the amount of rms signal strength (in microvolts) that is needed to produce a given amount of noise reduction. The noise in a receiver is greatly reduced when a strong signal is received. The reason is that the signal activates the AGC circuitry and reduces the gain in the RF stages. Refer to page 64 of the July 1986 issue, "Audio Corner," by Kirk Vistain.

7. B. Manufacturers of VCR equipment and the Electronic Industries Association/Consumer Products Group both recommend

the use of head cleaning sticks. The sticks use ultracleaned natural chamois leather for the cleaning material. Refer to page 28 of the August 1986 issue. The article is titled "Maintenance and Lubrication," by Conrad Persson.

8. A. In the continuing series titled "Audio Corner," Kirk Vistain recommends taking care to prevent static damage to the CMOS microcomputers. They, like all CMOS components, are susceptible to damage by static discharge.

9. A. Although the square wave test is more popular, the sawtooth wave test could be equally useful. In fact, the sawtooth test will show if clipping occurs, but the square wave test is not good for that purpose. Refer to page 58 of the August 1986 issue in an article titled "What Do You Know About Electronics?" by Sam Wilson.

10. A polar mount is so designed and constructed that it permits the antenna, when it is turned on a polar axis, to sweep or track the geosynchronous orbit. Refer to page 43 of the August 1986 issue, "Satellite Receiving Antennas," by Jim Kluge.

ES&T
in

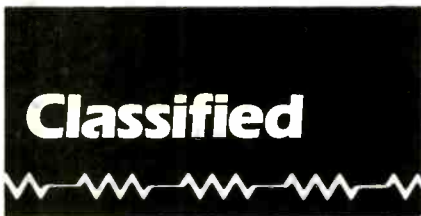

Advertising rates in the Classified Section are 75 cents per word, each insertion, and must be accompanied by payment to insure publications.

Each initial or abbreviation counts a full word.

Minimum classified charge is \$15.00.

For ads on which replies are sent to us for forwarding (blind ads), there is an additional charge of \$25.00 per insertion to cover department number, processing of replies, and mailing costs.

Classified columns are not open to advertising of any products regularly produced by manufacturers unless used and no longer owned by the manufacturer or distributor.

FOR SALE

AUTOMOBILE RADIO and tape replacement parts. Delco, Chrysler, Philco-Ford, Motorola, Panasonic and many others. Large inventory. Laran Electronics, Inc., 3768 Boston Road, Bronx, NY 10469. (212) 881-9600. National (800) 223-8314, NY State (800) 446-4430. 1-85-tfn

BOOTLEGGERS BIBLE for CB Modification \$12.95, CB Radio Repair \$10.95. Linear Amplifier Planbook \$14.95, kits, etc. Catalog \$1.00 refundable—APS, POB 263 Newport, R.I. 02840 401-846-5627. 12-84-tfn

CABLE TV CONVERTERS & EQUIPMENT. Plans and parts. Build or buy. Send S.A.S.E. C&D Electronics, P.O. Box 1402, Dept. ES&T, Hope, Arkansas 71801. 1-86-tfn

SONY-TRINITRON REBUILTS are now available. Call for price & delivery, 1-716-621-5250. 7-86-tfn

INDIVIDUAL PHOTOFAC FOLDERS (not sets) #1 to #1400, \$3.00 first-class postpaid. Loeb, 414 Chestnut Lane, East Meadow, NY 11554. 8-86-6t

TV TOUGH DOGS 200 symptoms and cures. Send \$6.95 to DAVIS TV, 11772 Old Fashion Way, Garden Grove, CA 92640. 9-86-3t

VCR REPAIR SOLUTIONS for VHS models. Over 125 symptoms and cures. The hard ones. Send \$9.95 to Eagle Electronics, 2534 Miracle Lane, Mishawaka, In. 46545. 9-86-3t

3000 COLOR TV REPAIR TIPS, 31 Brands 116 Page Manual. Send \$21.00 to A. Fernandez, Box 546110, Surfside, Florida 33154. 10-86-3t

FORSALE: Jerrold gated pulse theory. Twelve information packed pages covering DI & DIC converter operation. Includes introduction to trimode system. \$6.95 plus \$1.50 postage and handling. Elephant Electronics Inc., Box 41865-E, Phoenix, AZ 85080 (602) 581-1973. 10-86-tfn

FOR SALE: Descramble the latest video cassette copy protection scheme. Our simple LINE ZAPPER circuit takes the jitter out of your picture. Complete plans and theory only \$9.95 plus \$1.50 postage and handling. Printed circuit board or complete kit also available. Elephant Electronics Inc., Box 41865-E, Phoenix, AZ 85080 (602) 581-1973. 10-86-tfn

DISCOUNT CATV CONVERTERS/DECODERS and video accessories. Send for free information and prices—it could save you big money on your next purchase of these and other CATV items. Easy View, P.O. Box 221-1, Arlington Heights, IL 60006. (312) 952-8504. Ask for Rudy Valentine. 11-86-1t

SERVICE MANUALS. Large Shop has 18 yr. collection of duplicates. All original manufacturer. All new. Audio \$2.00, video \$5.00. Send SASE for list. Tape Recorder Clinic; 4850 E. Speedway; Tucson, Arizona 85712. 11-86-tfn

HELP WANTED

CAMERA-VIDEO Technicians needed. Top pay and benefits for well trained and experienced technicians who are expert with consumer and/or industrial cameras and VCR's. Training by manufacturers such as Sony, Hitachi, Panasonic, etc., are necessary for job experience. Come to sunny Florida and enjoy your work & leisure time. Write or call ATLANTIC ELECTRONICS INC., 1881 NE 26 St., Ft. Lauderdale, FL 33305. (305) 564-8274 10 AM to 6:30 PM. Ask for Dave or Joe. 8-85-tfn

ELECTRONIC TECHNICIAN/SERVICE SHOP MANAGER needed for small busy repair shop. Send resume to Whittington's Electronics, 501 Broadway, Truth or Consequences, New Mexico 87901. 10-86-2t

VIDEO/AUDIO technician needed. Top pay and benefits for well trained and experienced technicians who are expert with consumer TV and audio equipment. Training by manufacturers such as: Sony, Hitachi, RCA, Panasonic, etc. are necessary for job experience. Write or call: Atlantic Electronics, Inc., 1881 NE 26th St., Ft. Lauderdale, FL 33305, 305-564-8274 (10 AM 6:30 PM). Ask for Dave or Joe. 06-86-tfn

BUSINESS OPPORTUNITIES

T.V. SALES & SERVICE. Well established business located northern Virginia. Owner retiring and will help with financing. Call 703-972-7027 after 7:00 p.m. EST. 8/85-tfn

3 HOURS FROM SAN FRANCISCO, Electronic repair shop in Pine Forested foothills. Vision problem forces sale. 7 rm residence, lg beautiful gdn all shop equip included, \$155k min 50% dwn req (916) 872-1962. 10-86-tfn

RADIO-TV REPAIR SHOP! USA Virgin Islands! Established 15 years—reasonably priced—809-773-7867. 10-86-4t

BUSINESS OPPORTUNITIES

TV SERVICE BUSINESS in Southern California. 24 yrs. at same location. Nets \$50K. Call 714-897-7727, or write to Springdale TV, 157B2 Springdale Street, Huntington Beach, CA 92649. 11-86-11

SERVICES

REPAIR OF ZENITH CIRCUIT BOARD 9-160-all; with dud exchange \$33.00. One year guarantee. Kinirral Electronics, 68-26 64th Place, Glendale, N.Y. 11385. (718) 355-3859. 9-86-31

SERVICES

Zenith T.V. Module Repair 9-160-all modules \$33. with dud exchange. Most chromacolor II modules also repaired inexpensively. One year warranty. For complete list of modules repaired contact:
Weber Electronics
Hard Scramble Rd.
Hinsdale, N.Y. 14743
(716) 557-2135

Circle (28) on Reply Card

COLLEGE DEGREE

in **ELECTRONICS** by Home Study

• Fully Accredited by Accrediting Commission of NHSC •

No commuting to class. Study at your own pace, while continuing your present job. The Grantham home-study program leads first to the A.S.E.T. and then to the B.S.E.T. degree. Our free bulletin gives full details. Write for *Bulletin ET-86*.

Grantham College of Engineering
10570 Humbolt Street
Los Alamitos, California 90720

**PERSONALIZED 24-HOUR
SERVICE ON OVER
7,000 ELECTRONIC
COMPONENTS & PRODUCTS...**

CALL TOLL FREE

1-800-558-9572 IN WIS 1-800-242-9553



PROJECTOR RECORDER BELT
200 Clay Street • Whitewater, WI 53190
TLX 4994411 PRBUSA

Circle (22) on Reply Card

NATIONAL REBUILT HEADQ. FOR —

**SONY REBUILT
PICTURE TUBES**

2 YR. WARR. — FREE U.P.S. — DEL.

716-621-5250

Circle (23) on Reply Card

ATTENTION ELECTRONIC TECHNICIANS



Highly Effective Home Study BSEE Degree Program for Experienced Electronic Technicians. Our New Advanced Placement Program grants Credit for previous Schooling & Professional Experience. Advance Rapidly! Our 40th Year!

FREE DESCRIPTIVE LITERATURE!
Cook's Institute of Electronics Engineering
P.O. BOX 20345, JACKSON, MS 39209

Circle (24) on Reply Card

Advertisers' Index

	Page Number	Reader Service Number	Advertiser Hotline
B&K Precision Dynascan Corp.	27	10	312/889-9087
Beckman Industrial Corp.	49	16	714/671-4800
Contact East	59	19	800/225-5370
Cooks Inst. Elec. Engrg.	66	24	601/371-1351
Dandy Mfg. Co.	66	25	800/331-9658
Diehl Enterprises	15,17,19,21	8	806/359-0329
E.S.I., Inc.	13	5	800/645-4720
E-Z-Hook	9	6	818/446-6175
Electro Dynamics	55	17	800/IAM-NICE
ETA	59		
Grantham College of Engineering	66	9	800/762-4315
MCM Electronics	23	18	312/953-8950
NARDA	55		
NESDA	63		
Neosida Picture Tubes	66	23	716/621-5250
Projector Recorder Belt Corp.	66	22	800/558-9572
Sams, Howard W. & Co., Inc.	5	3	800/428-SAMS
Sencore, Inc.	41,43	12,13	800/843-3338
Sencore, Inc.	45,47	14,15	800/843-3338
Spectrum 2000 Inc.	63	21	800/922-6333
Sperry AW Instruments Inc.	IBC	2	800/645-5398
Sperry Tech, Inc.	66	26	800/228-4338
Tektronix, Inc.	IFC	1	800/433-2323
Tentel	10	7	800/538-6894
Tycor	29	11	800/661-9263
U.S. Instrument Rentals	7	4	800/824-2873
Underwater Vehicle Training Cnt.	59	20	713/690-0405
Unity Electronics	66	27	201/351-4200
Weber Electronics	66	28	716/557-2135
Zenith	BC		

DANDY-DAPTER™

PATENTED CRT ADAPTER—Don't buy another socket for your CRT Tester! This is the **Only** way you can win the Socket War! Guaranteed to fit your tester & allow you to test/clean/restore ANY Color, B/W, Projection, Scope or Camera CRTs. Visa/M-Card, Checks, CODs. New Low Price \$59.95 (We pay UPS) 1(800) 331-9658. DANDY ELECTRONICS. 2323 GIBSON, MUSKOGEE, OK 74403



Circle (25) on Reply Card

**NEW
20-PAGE
CATALOG FREE**

7 MILLION TUBES

Includes all current, obsolete, antique, hard-to-find receiving, transmitting, industrial, radio/TV types. **LOWEST PRICES.** Major brands in stock. Unity Electronics Dept. E
P.O. Box 213, Elizabeth, N.J. 07206



Circle (27) on Reply Card

Tech's
Guide
To
Pricing

"Tech's Guide To Pricing"

updated new 5th edition...a framework for setting rates that apply to Hi-Tech products...a formula that guarantees SUCCESS!

Call Toll Free for details
1-800-228-4338 B/S CST

Circle (26) on Reply Card

ELECTRONIC SERVICING & TECHNOLOGY Volume 6, No. 11 (USPS 462-050) is published monthly by Intertec Publishing Corp., 9221 Quivira Road, P.O. Box 12901, Overland Park, KS 66212. Second Class Postage paid at Shawnee Mission, KS, and additional mailing offices. POSTMASTER: Send address changes to ELECTRONIC SERVICING & TECHNOLOGY, P.O. Box 12952, Overland Park, KS 66212-9981.

ELECTRONIC

Servicing & Technology

KANSAS CITY, MISSOURI

Greg Garrison, Sales Manager
P.O. Box 12901
Overland Park, KS 66212
Phone: 1-913-888-4664

NORWOOD, AUSTRALIA

Hastwell, Williamson, Rouse PTY. LTD.
P.O. Box 419
Phone: 332-3322
Telex AA 87113

LONDON, ENGLAND

Nicholas McGeachin
Suite 460, Southbank House
Black Prince Road, London SE1 7SJ
Telex: 295555 LSPG
Telephones: Central Line 01 582-7522
Direct Line 01 587-1578

TOKYO, JAPAN

EMS, Inc.
Sagami Bldg., 4-2-21,
Shinjuku, Shinjuku-ku,
Tokyo 160, Japan
(03) 350-5666
Telex: 2322520 EMSINCJ
Cable: EMSINCPERIOD

AWS TEST INSTRUMENTS



DML-4020 DATA LOGGING DMM

This microprocessor controlled portable instrument contains two autoranging digital multimeters, four comparators, one timer and a 2 inch dotmatrix printer. Both DMM's may be used individually or simultaneously to measure and record all functions. The dot matrix printer provides numerical or graphic printouts displaying sampled values at pre-selected automatic or manual time intervals. The recordings end with a calculation of lowest/highest values, number of sample intervals and calculated average. Comparator output signals are available for actuating external equipment. **\$1,000.00.**



DM-6592 ELECTRO-PROBE™ DMM

One of the smallest, most convenient hand-held DMM's you'll ever own. It's both autoranging and manual and is the perfect instrument for taking readings easily and accurately in hard to reach areas. Other features include instant audible continuity buzzer; one-hand operation; electronic overload protection on all ranges; data-hold button. **Ranges:** 0-200m/2/20/200/500Vdc; 0-2/20/200/500Vac; 0-200/2K/20K/200K/2000K/20MΩ. **\$65.00.**



DM-7010 4½ DIGIT ROTARY SWITCH DMM

High accuracy readings in the laboratory or in the field. Features include 4½ digit 19999 max. display; built-in frequency counter to 200KHz and conductance function; 0.05% basic dc volts accuracy; overload protection on all ranges; special electronic protection to 250Vac/dc on resistance ranges; UL1244 type test leads; diode and continuity tests; **Ranges:** 0-200m/2/20/200/1000Vdc; 0-200m/2/20/200/750Vac; 0-200μ/2m/20m/200m/2/10Aac/dc; 0-200/2K/20K/200K/2M/20MΩ; 0-200nS conductance; 0-20K/200KHz frequency. **\$170.00.**



DM-1 POCKET-PRO™ DMM

Big features are packed in this pocket-calculator sized DMM. You'll find autoranging; electronic overload protection on all ranges; auto-polarity; audible and visual continuity indication; built-in test leads; "booklet-type" carrying case is designed to fit easily in shirt pocket. **Ranges:** 0-2000m/20/200/400Vac/dc; 0-200/2000/20K/200K/2000KΩ; 0-200Ω continuity. **\$29.95.**



BL-4 CLASSMATE DIGITAL BREADBOARD LAB

Nicknamed "The Instructor's Best Friend", this completely self-contained classroom lab combines a breadboard, DC power supply (fixed and variable), signal generator (sine, triangle and square wave cut-puts), digital voltmeter, 8-bit LED display, BCD to 7 segment decoder and display, flip-flop gate and logic switches in one compact unit. The BL-4 is only 11" x 13" leaving more work station area free for other instructional materials and requires only one electrical outlet. **\$349.95.**

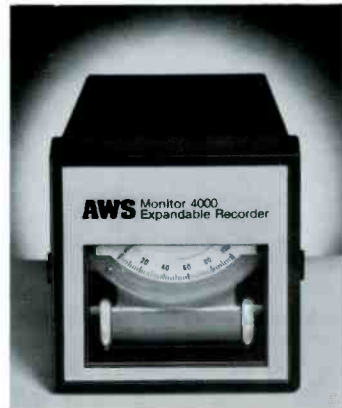

MONITOR 4000 EXPANDABLE RECORDING SYSTEM

The new recording system that can be expanded on as needed. Start with the XR-4000 basic 3 speed recorder, add any of five volt/amp or temperature modules, then select any of five transducers for easy current or temperature measurements. The XR-4000 can be panel mounted, used on a bench top or as a portable in its functionally designed carrying case. Basic XR-4000 3 speed recorder **\$229.95.** Complete kits start at **\$399.95** and include XR-4000, module, transducer, carrying case, chart paper, tilt stand.



DM-3000 3½ DIGIT ROTARY SWITCH DMM

Just one of three DMM's in our Economy Series that combines quality with economy. Features include built-in HFE, battery and diode testing; conductance function; 300 hour battery life; 10Aac range; electronic overload protection on all resistance ranges; pocket-sized. (Also available models DM-1000 & 2000). **Ranges:** 0-200m/2/20/200/1000Vdc; 0-200m/2/20/200/750Vac; 0-200μ/2m/20m/200m/10Aac/dc; 0-200/2K/20K/200K/2M/20MΩ; 1.5V battery test; 0-1000 Hfe test; 2KΩ diode test. DM-1000: **\$39.95** / DM-2000: **\$54.95** / DM-3000: **\$69.95.**



SP-5 POCKET-SIZE MULTIMETER

An unbelievable \$9.95 buys you this small yet surprisingly rugged multimeter. Perfect for the professional, homeowner and hobbyist. Its big features include safety recessed test lead connections; high impact ABS plastic case; mirrored scale plate; diode protected meter movement; uses only one 1.5V AA battery. **Ranges:** 0-10/50/250/500Vac/dc; 0-0.5/50/250mAdc; 0-1MΩ (5KΩ mid-scale); -20 to +56db. **\$9.95.**

A.W. SPERRY INSTRUMENTS INC.

For more information see your local distributor or contact A.W. Sperry Instruments Inc.
245 Marcus Blvd., Hauppauge, N.Y. 11788 • 800-645-5398 Toll-Free (N.Y. and Alaska call collect 516-231-7050).

Circle (2) on Reply Card

You bet you can make it big in the consumer electronics business by selling Zenith Video/Audio Accessories to the same people whose electronic products you now service.

Like all Zenith products, Zenith Audio/Video Accessories are made to the same uncompromising quality and performance standards that have earned Zenith a reputation unsurpassed in consumer electronics.

And it goes without saying that the better known and the more respected a product's name the easier, faster, and the more profitably you can sell it across the counter ...or while you're out of the shop on a service call.

To learn how it's done, how other service techs just like you are cashing in on the selling power of the Zenith name, call your Zenith distributor's Accessory Sales Manager now.

Everything you need is there at your Zenith distributor's place - the help and encouragement of an

experienced Zenith Accessory Sales Manager...the selling power of the Zenith name on video and audio accessories...and the overall support of your Zenith distributor's dedicated personnel.

With easy access to this wealth of know-how, you should have no trouble turning some 6, 7 or 8 feet of your floor space into a very respectable profit center. With Zenith Electronic Accessories, of course.

Call your Zenith distributor's Accessory Sales Manager now or write direct for the name of the Zenith distributor serving your area.

Call or write now, today!



The quality goes in before the name goes on.®

Zenith Service, Parts & Accessories • Department 30 • 11000 Seymour Avenue, Franklin Park, Illinois 60131 • A Division of Zenith Electronics Corporation

DEALER  **INQUIRIES INVITED**

